

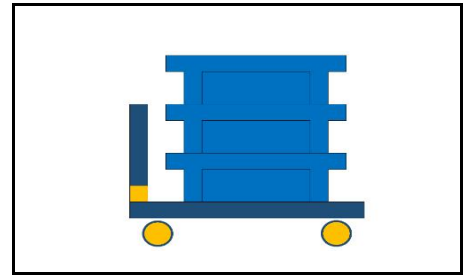

ENLIGHTENING PLAST

www.enlightening-plast.com

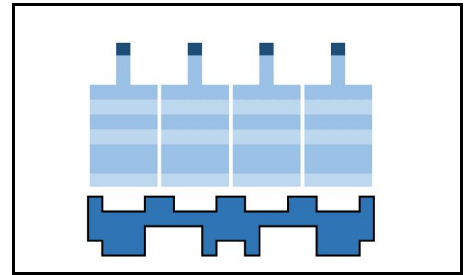
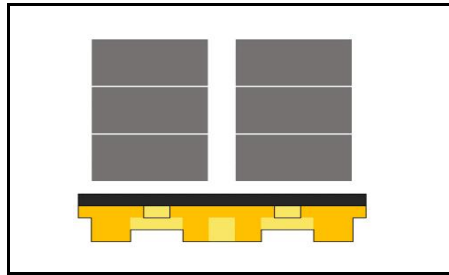
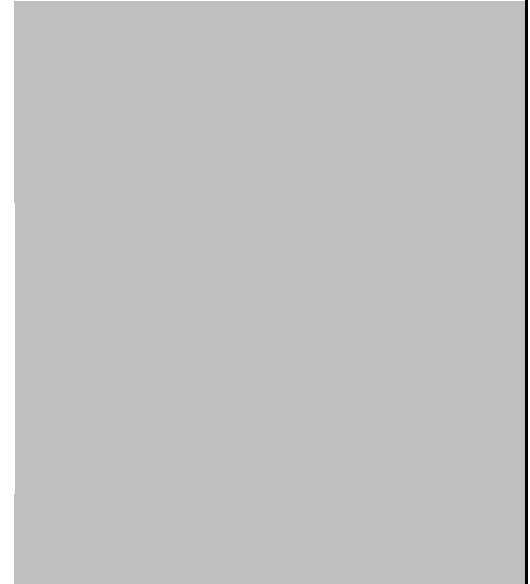
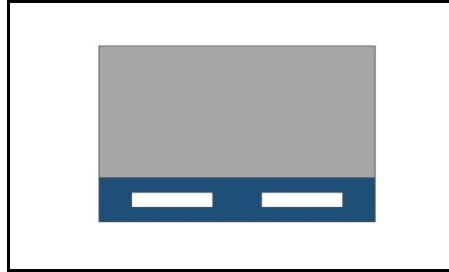
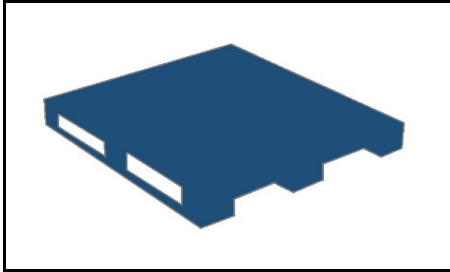

OUR PARTNERS

Coca-Cola



Continental 
The Future in Motion



P&G



雀巢  Nestlé

DHL

aramex



SAMSUNG



Carrefour 



SUNTORY

TABLE OF CONTENTS

<p>1 GRID SURFACE 3 RUNNERS</p> <p>2 FLAT SURFACE 3 RUNNERS</p> <p>3 GRID SURFACE 6 RUNNERS</p> <p>4 GRID SURFACE 6 RUNNERS</p> <p>5 FLAT SURFACE 6 RUNNERS</p> <p>6 GRID SURFACE 9 LEGS NESTABLE</p> <p>7 FLAT SURFACE 9 LEGS NESTABLE</p> <p>8 GRID SURFACE 9 LEGS</p> <p>9 FLAT SURFACE 9 LEGS</p> <p>10 GRID SURFACE REVERSIBLE</p> <p>11 GRID SURFACE REVERSIBLE</p> <p>12 GRID SURFACE REVERSIBLE</p> <p>13 FLAT SURFACE REVERSIBLE</p> <p>14 FLAT SURFACE REVERSIBLE</p> <p>15 SPILL PALLETS & WATER BOTTLES PALLETS</p> <p>16 PALLET CONTAINERS</p> <p>17 PALLET CONTAINERS</p>	<p>18 PLASTIC WASTE BINS</p> <p>19 STACKABLE SOLID CRATES - FOOD GRADE</p> <p>20 STACKABLE SOLID CRATES - FOOD GRADE</p> <p>21 STACKABLE SOLID CRATES - INDUSTRIAL</p> <p>22 STACKABLE VENTED CRATES - FOOD GRADE</p> <p>23 STACKABLE VENTED CRATES - FOOD GRADE</p> <p>24 ATTACHED LID CONTAINER</p> <p>25 VENTED CRATES</p> <p>26 VENTED CRATES - STEEL HANDLE</p> <p>27 HANG AND SHELF BINS</p>
--	--

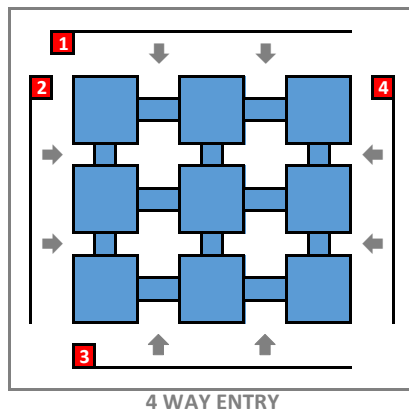
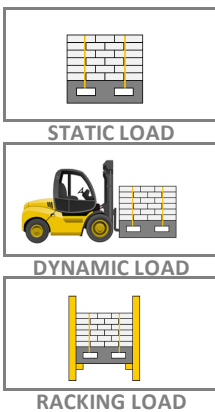

ABOUT US :

Enlightening is a medium-sized company, having 400 employees, established at 2000 based in China, having two huge manufacturing facilities located Shanghai, China

With total area of 90,000 meter square, 60 sets of production lines, and 700 Plastic injection molds

ENLIGHTENING Annual Turnover reach 90 -100 million us dollar, overseas sales make up 30% of the total value, we are proud to be one of the biggest exporters for plastic pallets around the world.

Our sales team in china are covering more than 40 countries globally

Through hardworking and passion, the company has grown over the last 20 years into one of the leading Chinese manufacturers of transport and storage products made from synthetic materials. With outstanding value for money, a comprehensive product range, and our high-quality service, we want to offer an unforgettable shopping experience for our customers – from ordering to dispatching the required item.

ENLIGHTENING has 60 sets of injection machines, with different sizes and capacities - up to 4000 TON

GRID SURFACE | 3 RUNNERS

ONE TIME INJECTION

RACKABLE

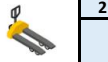

ENL-1008CWZJ 100 x 80 x 15 cm

WEIGHT ± 5%	9.0 kg	13.5 kg	(7 BARS)
LOAD CAPACITY			
	6 T	1.5T	1 T
CONTAINER	20FT	290	40HC 720

ENL-1010H2 100 x 100 x 15 cm

WEIGHT ± 5%	13.6 kg	19.6 kg	(8 BARS)
LOAD CAPACITY			
	6 T	1.5T	1 T
CONTAINER	20FT	240	40HC 600

ENL-Y1111WHC 110 x 110 x 15 cm

WEIGHT ± 5%	14.0 kg	20.5 kg	(8 BARS)
LOAD CAPACITY			
	6 T	1.5T	1 T
CONTAINER	20FT	190	40HC 462

ENL-Y1208WHB 120 x 80 x 15 cm

WEIGHT ± 5%	11.0 kg	16.0 kg	(8 BARS)
LOAD CAPACITY			
	6 T	1.5T	1 T
CONTAINER	20FT	220	40HC 600

ENL-Y1210WHC 120 x 100 x 15 cm

WEIGHT ± 5%	13.5 kg	20.5 kg	(8 BARS)
LOAD CAPACITY			
	6 T	1.5T	1 T
CONTAINER	20FT	210	40HC 530

ENL-Y1211WHC 120 x 110 x 15 cm

WEIGHT ± 5%	15.7 kg	22.7 kg	(8 BARS)
LOAD CAPACITY			
	6 T	1.5T	1 T
CONTAINER	20FT	180	40HC 450

ENL-Y1212WHC 120 x 120 x 15 cm

WEIGHT ± 5%	16.5 kg	23.5 kg	(8 BARS)
LOAD CAPACITY			
	6 T	1.5T	1 T
CONTAINER	20FT	170	40HC 420

ENL-Y1311WHC 130 x 110 x 15 cm

WEIGHT ± 5%	16.3 kg	24.3 kg	(8 BARS)
LOAD CAPACITY			
	6 T	1.5T	1 T
CONTAINER	20FT	170	40HC 400

ENL-1313H2 130 x 130 x 15 cm

WEIGHT ± 5%	23.5 kg	35.5 kg	(8 BARS)
LOAD CAPACITY			
	6 T	1.5T	1 T
CONTAINER	20FT	150	40HC 380

ENL-Y1411WHC 140 x 110 x 15 cm

WEIGHT ± 5%	18.3 kg	27.3 kg	(8 BARS)
LOAD CAPACITY			
	6 T	1.5T	1 T
CONTAINER	20FT	150	40HC 380

ENL-Y1412WHC 140 x 120 x 16 cm

WEIGHT ± 5%	20.5 kg	29.5 kg	(8 BARS)
LOAD CAPACITY			
	6 T	1.5T	1 T
CONTAINER	20FT	130	40HC 330

ENL-Y144115WHC 144 x 115 x 16 cm

WEIGHT ± 5%	20.0 kg	29.0 kg	(8 BARS)
LOAD CAPACITY			
	6 T	1.5 T	1 T
CONTAINER	20FT	130	40HC 330

FLAT SURFACE | 3 RUNNERS

WELDED

RACKABLE



4 WAY	✓
-------	---



2 WAY	✓
-------	---

ENL-1010H 100 x 100 x 16.5 cm

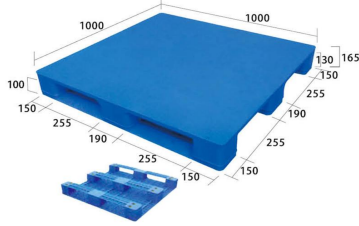

WEIGHT ± 5%	14.6 kg	21.6 kg	(7 BARS)
LOAD CAPACITY	6 T	2 T	1.5 T
CONTAINER	20FT	240	40HC 600

ENL-1111PGC 110 x 110 x 15 cm

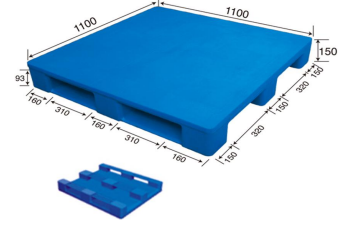

WEIGHT ± 5%	18.0 kg	23.4 kg	(5 BARS)
LOAD CAPACITY	6 T	2 T	1.5 T
CONTAINER	20FT	180	40HC 462

ENL-H1111PHB 110 x 110 x 15 cm

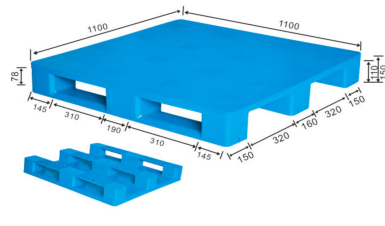

WEIGHT ± 5%	16.9 kg	23.9 kg	(8 BARS)
LOAD CAPACITY	6 T	2 T	1.5 T
CONTAINER	20FT	180	40HC 450

ENL-1208PGC 120 x 80 x 15 cm

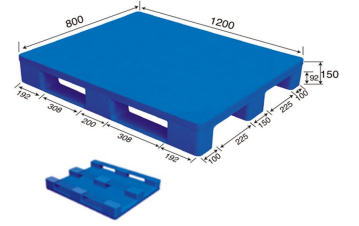

WEIGHT ± 5%	16.4 kg	21.4 kg	(5 BARS)
LOAD CAPACITY	6 T	2 T	1.5 T
CONTAINER	20FT	210	40HC 520

ENL-H1208PHA 120 x 80 x 15 cm

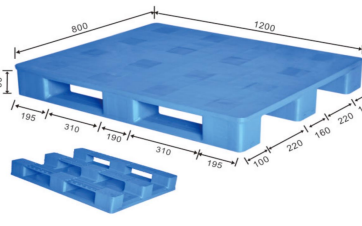

WEIGHT ± 5%	13.9 kg	20.9 kg	(8 BARS)
LOAD CAPACITY	6 T	2 T	1.5 T
CONTAINER	20FT	210	40HC 520

ENL-1210PGC 120 x 100 x 15 cm

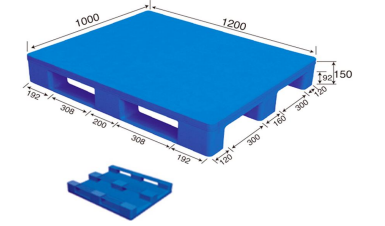

WEIGHT ± 5%	18.0 kg	23.5 kg	(5 BARS)
LOAD CAPACITY	6 T	2 T	1.5 T
CONTAINER	20FT	190	40HC 470

ENL-H1210PHA 120 x 100 x 15 cm

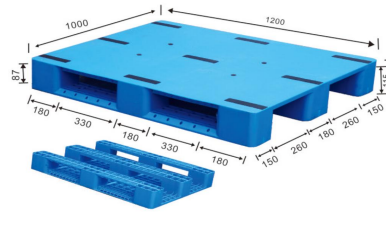

WEIGHT ± 5%	16.0 kg	22.8 kg	(8 BARS)
LOAD CAPACITY	6 T	2 T	1.5 T
CONTAINER	20FT	200	40HC 500

ENL-H1211PHA 120 x 110 x 15 cm

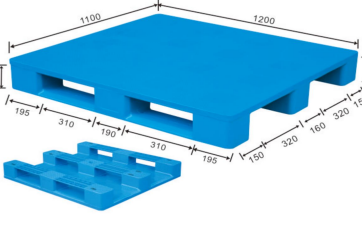

WEIGHT ± 5%	20.0 kg	28.0 kg	(8 BARS)
LOAD CAPACITY	6 T	2 T	1.5 T
CONTAINER	20FT	170	40HC 430

ENL-H1211PHB 120 x 110 x 15 cm

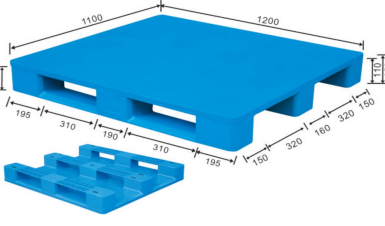

WEIGHT ± 5%	19.5 kg	26.5 kg	(8 BARS)
LOAD CAPACITY	6 T	2 T	1.5 T
CONTAINER	20FT	170	40HC 430

ENL-H1212PHA 120 x 120 x 16 cm

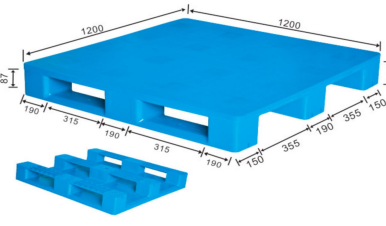

WEIGHT ± 5%	20.8 kg	28.8 kg	(8 BARS)
LOAD CAPACITY	6 T	2 T	1.5 T
CONTAINER	20FT	170	40HC 420

ENL-H1311PHA 130 x 110 x 16 cm

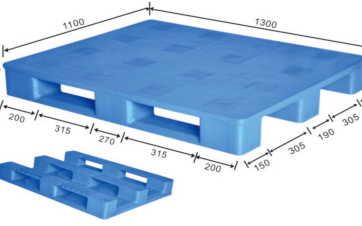

WEIGHT ± 5%	21.5 kg	29.5 kg	(8 BARS)
LOAD CAPACITY	6 T	2 T	1.5 T
CONTAINER	20FT	150	40HC 380

ENL-1313H 130 x 130 x 15 cm

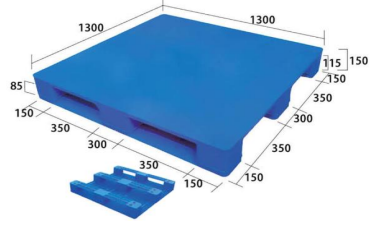

WEIGHT ± 5%	24.0 kg	33.0 kg	(8 BARS)
LOAD CAPACITY	6 T	2 T	1.5 T
CONTAINER	20FT	150	40HC 380

GRID SURFACE | 6 RUNNERS

ONE TIME INJECTION

RACKABLE

STACKABLE



ENL-Y1111WTD 110 x 110 x 15 cm

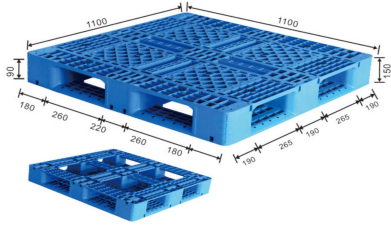

WEIGHT ± 5%	14.5 kg	21.5 kg	(8 BARS)
LOAD CAPACITY	6 T	1.5 T	1 T
CONTAINER	20FT	145	40HC 362

ENL-Y1111WTC 110 x 110 x 12 cm

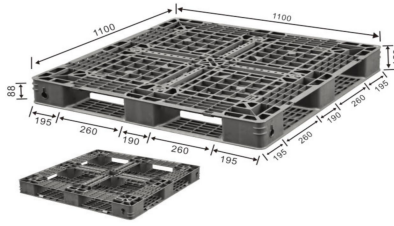

WEIGHT ± 5%	7.2 kg		
LOAD CAPACITY	2 T	1 T	X
CONTAINER	20FT	180	40HC 450

ENL-Y1208WTC 120 x 80 x 13.5 cm

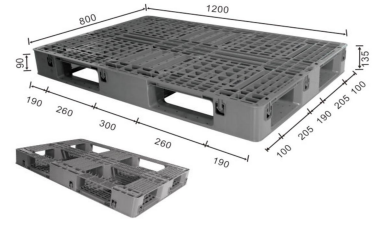

WEIGHT ± 5%	10.0 kg	14.5 kg	(3 BARS)
LOAD CAPACITY	4 T	1.5 T	1 T
CONTAINER	20FT	220	40HC 535

ENL-Y1210WTE 120 x 100 x 15 cm

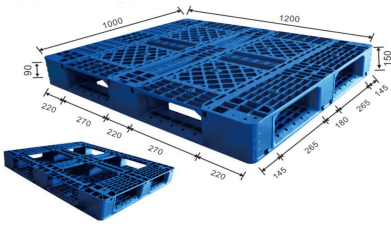

WEIGHT ± 5%	14.7 kg	21.7 kg	(8 BARS)
LOAD CAPACITY	6 T	1.5 T	1 T
CONTAINER	20FT	150	40HC 367

ENL-Y1210WTC 120 x 100 x 12 cm

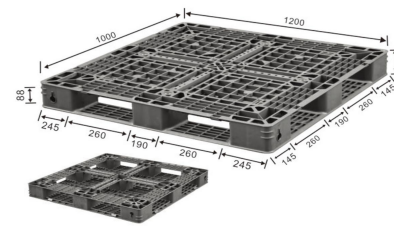

WEIGHT ± 5%	7.2 kg		
LOAD CAPACITY	2 T	1 T	X
CONTAINER	20FT	180	40HC 450

ENL-Y1211WTA 120 x 110 x 15 cm

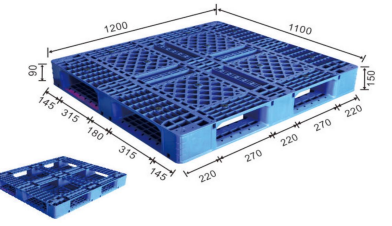

WEIGHT ± 5%	15.0 kg	22.0 kg	(8 BARS)
LOAD CAPACITY	6 T	1.5 T	1 T
CONTAINER	20FT	140	40HC 340

ENL-Y1212WTB 120 x 120 x 15 cm

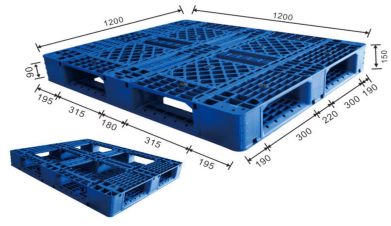

WEIGHT ± 5%	16.5 kg	23.5 kg	(8 BARS)
LOAD CAPACITY	6 T	1.5 T	1 T
CONTAINER	20FT	120	40HC 310

ENL-Y1411WTA 140 x 110 x 15 cm

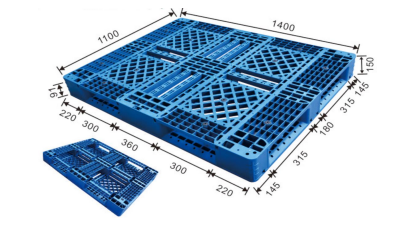

WEIGHT ± 5%	17.0 kg	26.0 kg	(8 BARS)
LOAD CAPACITY	6 T	1.5 T	1 T
CONTAINER	20FT	115	40HC 280

ENL-Y1412WTA 140 x 120 x 15 cm

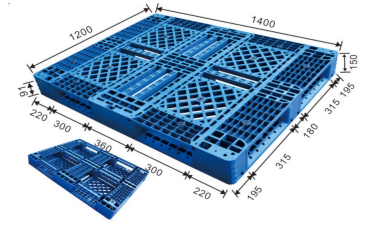

WEIGHT ± 5%	19.0 kg	28.0 kg	(8 BARS)
LOAD CAPACITY	6 T	1.5 T	1 T
CONTAINER	20FT	105	40HC 272

GRID SURFACE | 6 RUNNERS

WELDED

RACKABLE

STACKABLE



ENL-H1111WTC 110 x 110 x 15 cm

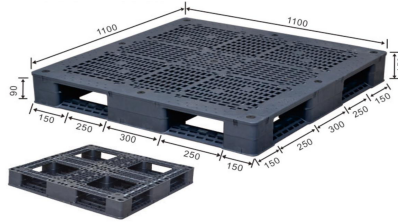

WEIGHT ± 5%	16.0 kg	23.0 kg (12 BARS)
LOAD CAPACITY	6 T	1.5 T
CONTAINER	20FT 145	40HC 362

ENL-H1210WTB 120 x 100 x 15 cm

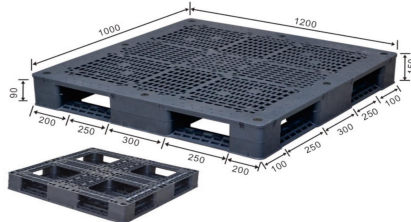

WEIGHT ± 5%	17.0 kg	24.0 kg (12 BARS)
LOAD CAPACITY	6 T	1.5 T
CONTAINER	20FT 150	40HC 367

ENL-H1211WTB 120 x 110 x 15 cm

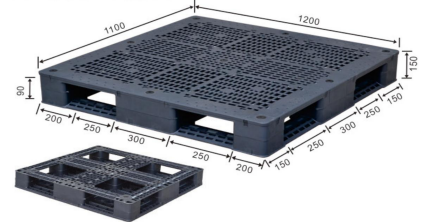

WEIGHT ± 5%	17.5 kg	24.5 kg (12 BARS)
LOAD CAPACITY	6 T	1.5 T
CONTAINER	20FT 140	40HC 340

ENL-H1212WTB 120 x 120 x 15 cm

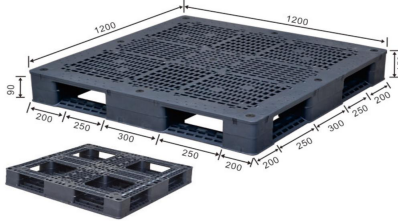

WEIGHT ± 5%	18.7 kg	26.7 kg (12 BARS)
LOAD CAPACITY	6 T	1.5 T
CONTAINER	20FT 120	40HC 310

ENL-H1311WTA 130 x 110 x 15 cm

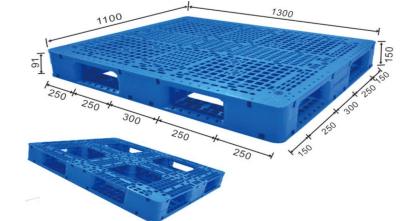

WEIGHT ± 5%	19.5 kg	27.5 kg (8 BARS)
LOAD CAPACITY	6 T	1.5 T
CONTAINER	20FT 125	40HC 310

ENL-1313C 130 x 130 x 16 cm

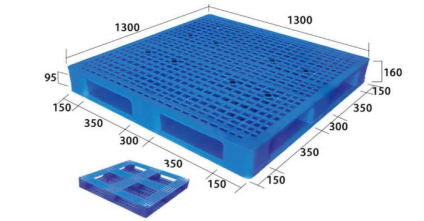

WEIGHT ± 5%	24.0 kg	28.6 kg (4 BARS)
LOAD CAPACITY	6 T	1.5 T
CONTAINER	20FT 105	40HC 264

ENL-H1411WTA 140 x 110 x 15 cm

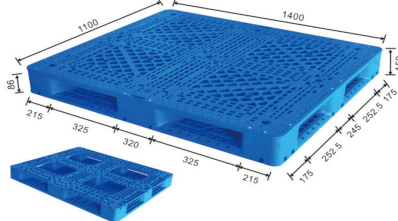

WEIGHT ± 5%	23.0 kg	32.0 kg (16 BARS)
LOAD CAPACITY	6 T	1.5 T
CONTAINER	20FT 115	40HC 280

ENL-H1412WTA 140 x 120 x 15 cm

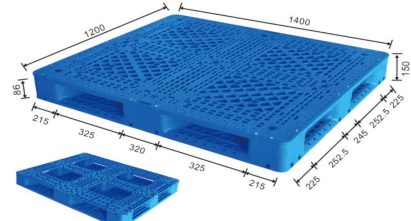

WEIGHT ± 5%	26.5 kg	35.5 kg (12 BARS)
LOAD CAPACITY	6 T	1.5 T
CONTAINER	20FT 105	40HC 272

ENL-1414C 140 x 140 x 16 cm

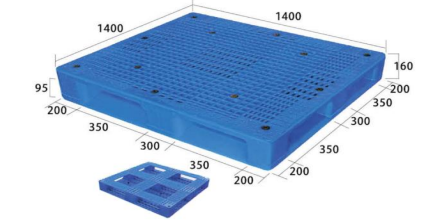

WEIGHT ± 5%	30.0 kg	35.0 kg (6 BARS)
LOAD CAPACITY	6 T	1.5 T
CONTAINER	20FT 60	40HC 145

ENL-1515C 150 x 150 x 16 cm

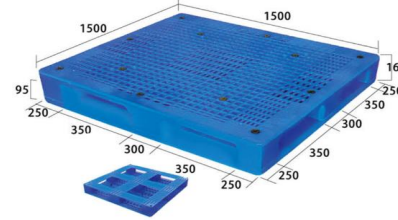

WEIGHT ± 5%	34.0 kg	39.8 kg (6 BARS)
LOAD CAPACITY	6 T	1.5 T
CONTAINER	20FT 68	40HC 168

FLAT SURFACE | 6 RUNNERS

WELDED

RACKABLE

STACKABLE



ENL-110830G 110 x 83 x 17.5 cm

WEIGHT ± 5%	13.1 kg	15.6 kg (3 BARS)
LOAD CAPACITY	6 T	1.5 T
CONTAINER	20FT 130	40HC 300

ENL-H1111PTC 110 x 110 x 15 cm

WEIGHT ± 5%	16.5 kg	23.5 kg (12 BARS)
LOAD CAPACITY	6 T	1.5 T
CONTAINER	20FT 140	40HC 352

ENL-1208B1 120 x 80 x 15 cm

WEIGHT ± 5%	18.0 kg	
LOAD CAPACITY	4 T	1 T
CONTAINER	20FT 150	40HC 375

ENL-H1210PTB 120 x 100 x 15 cm

WEIGHT ± 5%	17.0 kg	28.0 kg (12 BARS)
LOAD CAPACITY	6 T	1.5 T
CONTAINER	20FT 150	40HC 367

ENL-H1211PTB 120 x 110 x 15 cm

WEIGHT ± 5%	19.4 kg	27.4 kg (12 BARS)
LOAD CAPACITY	6 T	1.5 T
CONTAINER	20FT 120	40HC 310

ENL-H1212PTB 120 x 120 x 15 cm

WEIGHT ± 5%	19.7 kg	27.7 kg (12 BARS)
LOAD CAPACITY	6 T	1.5 T
CONTAINER	20FT 120	40HC 310

ENL-H1311PTA 130 x 110 x 15 cm

WEIGHT ± 5%	27.6 kg	35.6 kg (12 BARS)
LOAD CAPACITY	6 T	1.5 T
CONTAINER	20FT 125	40HC 310

ENL-1313C 130 x 130 x 15 cm

WEIGHT ± 5%	26.5 kg	31.1 kg (4 BARS)
LOAD CAPACITY	6 T	2 T
CONTAINER	20FT 120	40HC 310

ENL-H1411PTA 140 x 110 x 15 cm

WEIGHT ± 5%	23.0 kg	33.0 kg (12 BARS)
LOAD CAPACITY	6 T	2 T
CONTAINER	20FT 115	40HC 280

ENL-H1412PTA 140 x 120 x 15 cm

WEIGHT ± 5%	28.0 kg	38.0 kg (12 BARS)
LOAD CAPACITY	6 T	2 T
CONTAINER	20FT 105	40HC 272

GRID SURFACE | 9 LEGS NESTABLE

ONE TIME INJECTION

GROUND USE

EXPORT USE



ENL-Y1008WQA 100 x 80 x 14 cm

WEIGHT ± 5%	4.9 kg
LOAD CAPACITY	
CONTAINER	20FT 600 40HC 1450

ENL-Y1010WQA 100 x 100 x 14 cm

WEIGHT ± 5%	5.7 kg
LOAD CAPACITY	
CONTAINER	20FT 550 40HC 1300

ENL-Y1109WQA 110 x 90 x 14 cm

WEIGHT ± 5%	6.2 kg
LOAD CAPACITY	
CONTAINER	20FT 470 40HC 1150

ENL-Y1110WQA 110 x 100 x 14 cm

WEIGHT ± 5%	6.7 kg
LOAD CAPACITY	
CONTAINER	20FT 450 40HC 1100

ENL-Y1111WQC 110 x 110 x 14 cm

WEIGHT ± 5%	6.7 kg
LOAD CAPACITY	
CONTAINER	20FT 450 40HC 1100

ENL-Y1111WQB 110 x 110 x 14 cm

WEIGHT ± 5%	6.2 kg
LOAD CAPACITY	
CONTAINER	20FT 450 40HC 1100

ENL-Y1111WQA 110 x 110 x 13.5 cm

WEIGHT ± 5%	7.8 kg
LOAD CAPACITY	
CONTAINER	20FT 410 40HC 1050

ENL-Y1208WQA 120 x 80 x 13.5 cm

WEIGHT ± 5%	5.8 kg
LOAD CAPACITY	
CONTAINER	20FT 500 40HC 1200

ENL-Y1210WQB 120 x 100 x 14 cm

WEIGHT ± 5%	6.2 kg
LOAD CAPACITY	
CONTAINER	20FT 400 40HC 1166

ENL-Y1210WQA 120 x 100 x 14 cm

WEIGHT ± 5%	7.5 kg
LOAD CAPACITY	
CONTAINER	20FT 400 40HC 1166

ENL-Y1211WQA 120 x 110 x 14 cm

WEIGHT ± 5%	6.8 kg
LOAD CAPACITY	
CONTAINER	20FT 440 40HC 900

ENL-Y1212WQA 120 x 120 x 13.5 cm

WEIGHT ± 5%	8.8 kg
LOAD CAPACITY	
CONTAINER	20FT 370 40HC 830

FLAT SURFACE | 9 LEGS NESTABLE

ONE TIME INJECTION

GROUND USE

EXPORT USE



ENL-Y11473PQJ 114 x 73.0 x 14.5 cm

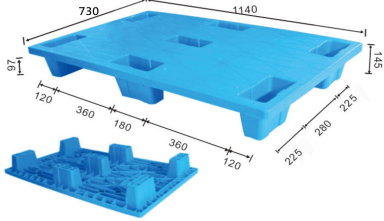

WEIGHT ± 5%	6.6 kg			
LOAD CAPACITY				
	1.5T	0.5 T		X
CONTAINER	20FT	450	40HC	1100

ENL-Y11473PQJ 114 x 73.5 x 14.5 cm

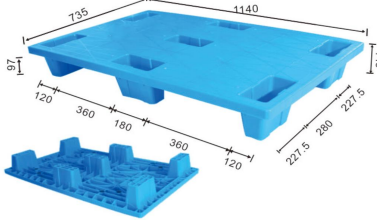

WEIGHT ± 5%	6.6 kg			
LOAD CAPACITY				
	1.5T	0.5 T		X
CONTAINER	20FT	450	40HC	1100

ENL-Y11573PQJ 115 x 73 x 15 cm

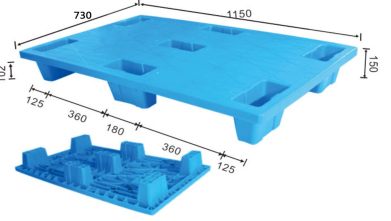

WEIGHT ± 5%	6.9 kg			
LOAD CAPACITY				
	1.5T	0.5 T		X
CONTAINER	20FT	450	40HC	1100

ENL-Y11574PQJ 115 x 74 x 15 cm

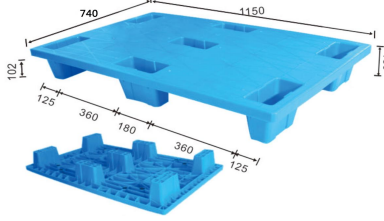

WEIGHT ± 5%	6.9 kg			
LOAD CAPACITY				
	1.5T	0.5 T		X
CONTAINER	20FT	450	40HC	1100

ENL-Y11575PQJ 115 x 75 x 15 cm

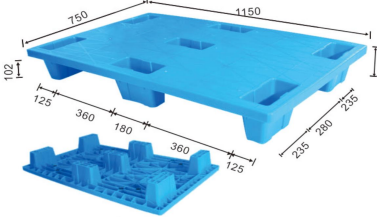

WEIGHT ± 5%	6.9 kg			
LOAD CAPACITY				
	1.5T	0.5 T		X
CONTAINER	20FT	450	40HC	1100

ENL-Y1111PQA 110 x 110 x 13.5 cm

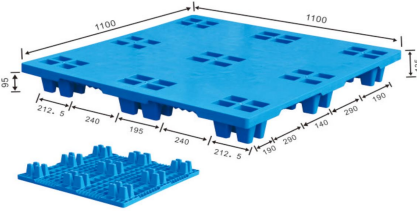

WEIGHT ± 5%	9.3 kg			
LOAD CAPACITY				
	1.5T	0.5 T		X
CONTAINER	20FT	410	40HC	1050

ENL-1111CS 110 x 110 x 15 cm

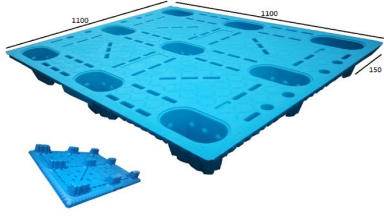

WEIGHT ± 5%	8.5 kg			
LOAD CAPACITY				
	3T	0.8 T		X
CONTAINER	20FT	400	40HC	1000

ENL-Y1208PQA 120 x 80 x 13.5 cm

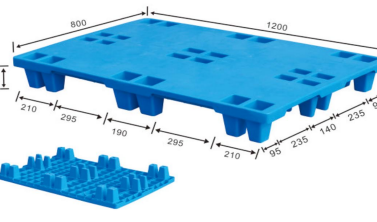

WEIGHT ± 5%	7.0 kg			
LOAD CAPACITY				
	1.5T	0.5 T		X
CONTAINER	20FT	500	40HC	1200

ENL-1210CS 120 x 100 x 15 cm

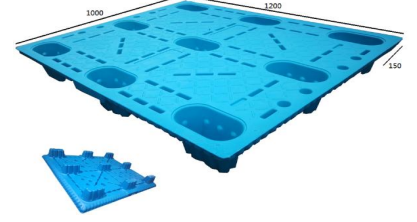

WEIGHT ± 5%	8.5 kg			
LOAD CAPACITY				
	1.5T	0.5 T		X
CONTAINER	20FT	400	40HC	1000

ENL-Y1212PQA 120 x 120 x 13.5 cm

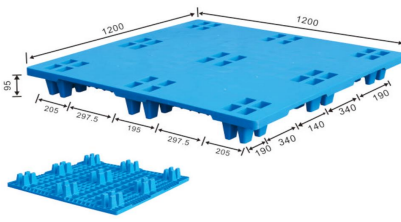

WEIGHT ± 5%	10.9 kg			
LOAD CAPACITY				
	1.5T	0.5 T		X
CONTAINER	20FT	370	40HC	830

GRID SURFACE | 9 LEGS

ONE TIME INJECTION

GROUND USE

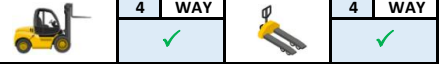

ENL-Y1008WJA 100 x 80 x 15 cm

WEIGHT ± 5%	8.1 kg	10.1 kg	(4 BARS)
LOAD CAPACITY			
CONTAINER	20FT	280	40HC 700

ENL-Y1010WJA 100 x 100 x 15 cm

WEIGHT ± 5%	8.7 kg	11.2 kg	(4 BARS)
LOAD CAPACITY			
CONTAINER	20FT	240	40HC 600

ENL-Y1109WJA 110 x 90 x 15 cm

WEIGHT ± 5%	9.2 kg	11.7 kg	(4 BARS)
LOAD CAPACITY			
CONTAINER	20FT	240	40HC 600

ENL-Y1111WJA 110 X 110 X 14.5 cm

WEIGHT ± 5%	13.3 kg	16.3 kg	(4 BARS)
LOAD CAPACITY			
CONTAINER	20FT	240	40HC 580

ENL-Y1208WJA 120 x 80 x 14.5 cm

WEIGHT ± 5%	11.0 kg	14.0 kg	(4 BARS)
LOAD CAPACITY			
CONTAINER	20FT	240	40HC 600

ENL-Y1210WJB 120 x 100 x 14 cm

WEIGHT ± 5%	12.4 kg	15.4 kg	(4 BARS)
LOAD CAPACITY			
CONTAINER	20FT	200	40HC 500

ENL-Y1211WJA 120 x 110 x 14 cm

WEIGHT ± 5%	12.5 kg	15.5 kg	(4 BARS)
LOAD CAPACITY			
CONTAINER	20FT	160	40HC 400

ENL-Y1212WJB 120 x 120 x 14 cm

WEIGHT ± 5%	14.7 kg	17.7 kg	(4 BARS)
LOAD CAPACITY			
CONTAINER	20FT	160	40HC 400

ENL-Y1311WJA 130 x 110 x 14.5 cm

WEIGHT ± 5%	14.7 kg	18.2 kg	(4 BARS)
LOAD CAPACITY			
CONTAINER	20FT	130	40HC 310

ENL-Y1411WJB 140 x 110 x 14.8 cm

WEIGHT ± 5%	17.7 kg	21.4 kg	(4 BARS)
LOAD CAPACITY			
CONTAINER	20FT	115	40HC 280

ENL-Y1412WJA 140 x 120 x 14.5 cm

WEIGHT ± 5%	18.9 kg	22.9 kg	(4 BARS)
LOAD CAPACITY			
CONTAINER	20FT	118	40HC 272

ENL-Y1414WJA 140 x 140 x 14.5 cm

WEIGHT ± 5%	17.8 kg	23.3 kg	(6 BARS)
LOAD CAPACITY			
CONTAINER	20FT	68	40HC 168

FLAT SURFACE | 9 LEGS

ONE TIME INJECTION

GROUND USE



4	WAY
✓	



4	WAY
✓	

ENL-Y1008PJA 100 x 80 x 15 cm

WEIGHT ± 5%	8.7 kg	10.7 kg	(3 BARS)
LOAD CAPACITY			
	4T	1 T	X
CONTAINER	20FT	280	40HC 700

ENL-Y1010PJA 100 x 100 x 15 cm

WEIGHT ± 5%	9.9 kg	12.4 kg	(4 BARS)
LOAD CAPACITY			
	4T	1 T	X
CONTAINER	20FT	240	40HC 600

ENL-Y1109PJA 110 x 90 x 15 cm

WEIGHT ± 5%	10.8 kg	13.3 kg	(4 BARS)
LOAD CAPACITY			
	4T	1 T	X
CONTAINER	20FT	240	40HC 600

ENL-Y1111PJA 110 x 110 x 14.5 cm

WEIGHT ± 5%	14.6 kg	17.1 kg	(4 BARS)
LOAD CAPACITY			
	4T	1 T	X
CONTAINER	20FT	240	40HC 580

ENL-Y1208PJB 120 x 80 x 15 cm

WEIGHT ± 5%	11.0 kg	14.0 kg	(4 BARS)
LOAD CAPACITY			
	4T	1 T	X
CONTAINER	20FT	200	40HC 500

ENL-Y1210PJB 120 x 100 x 14 cm

WEIGHT ± 5%	13.4 kg	16.4 kg	(4 BARS)
LOAD CAPACITY			
	4T	1 T	X
CONTAINER	20FT	200	40HC 500

ENL-Y1211PJA 120 x 110 x 14 cm

WEIGHT ± 5%	15.3 kg	18.3 kg	(4 BARS)
LOAD CAPACITY			
	4T	1 T	X
CONTAINER	20FT	160	40HC 400

ENL-Y1212PJB 120 x 120 x 14 cm

WEIGHT ± 5%	15.6 kg	19.0 kg	(4 BARS)
LOAD CAPACITY			
	4T	1 T	X
CONTAINER	20FT	160	40HC 400

ENL-Y1311PJA 130 x 110 x 14.5 cm

WEIGHT ± 5%	17.4 kg	20.9 kg	(4 BARS)
LOAD CAPACITY			
	4T	1 T	X
CONTAINER	20FT	130	40HC 310

ENL-Y1411PJA 140 x 110 x 14.5 cm

WEIGHT ± 5%	22.2 kg	26.2 kg	(4 BARS)
LOAD CAPACITY			
	4T	1 T	X
CONTAINER	20FT	115	40HC 280

ENL-Y1412PJA 140 x 120 x 14.5 cm

WEIGHT ± 5%	23.3 kg	27.3 kg	(4 BARS)
LOAD CAPACITY			
	4T	1 T	X
CONTAINER	20FT	118	40HC 272

ENL-Y1414PJA 140 x 140 x 14.5 cm

WEIGHT ± 5%	25.7 kg	30.3 kg	(4 BARS)
LOAD CAPACITY			
	4T	1 T	X
CONTAINER	20FT	68	40HC 168

GRID SURFACE | REVERSIBLE

ONE TIME INJECTION

RACKABLE

STACKABLE

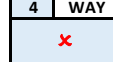

ENL-Y1111WSA 110 x 110 x 15 cm

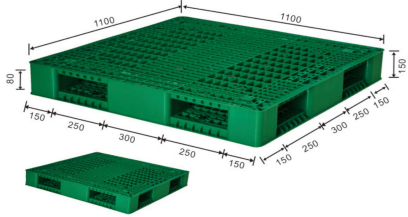

WEIGHT ± 5%	19.0 kg			
LOAD CAPACITY				
	6 T	1.5 T	0.5 T	
CONTAINER	20FT	145	40HC	362

ENL-Y1111WSB 110 x 110 x 15 cm

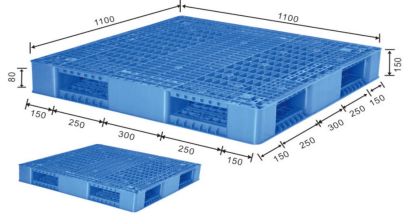

WEIGHT ± 5%	21.0 kg			
LOAD CAPACITY				
	6 T	1.5 T	0.5 T	
CONTAINER	20FT	145	40HC	362

ENL-Y1111WSC 110 x 110 x 15 cm

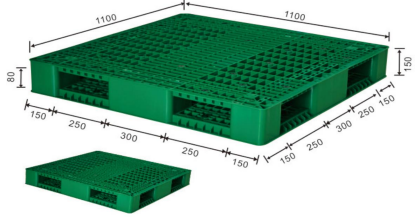

WEIGHT ± 5%	22.0 kg			
LOAD CAPACITY				
	6 T	1.5 T	0.5 T	
CONTAINER	20FT	145	40HC	362

ENL-Y1111WSE 110 x 110 x 15 cm

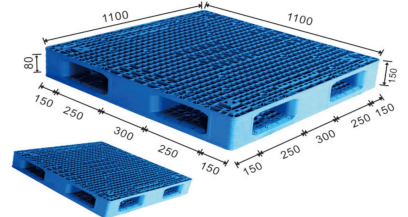

WEIGHT ± 5%	19.5 kg			
LOAD CAPACITY				
	6 T	1.5 T	0.5 T	
CONTAINER	20FT	145	40HC	362

ENL-Y1210WSC 120 x 100 x 15 cm

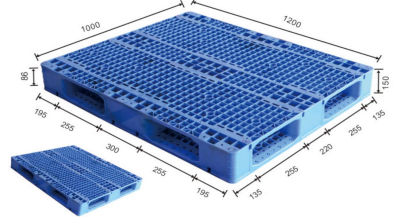

WEIGHT ± 5%	19.5 kg	25.5 kg (8 BARS)		
LOAD CAPACITY				
	6 T	1.5 T	1 T	
CONTAINER	20FT	150	40HC	367

ENL-Y1210WSB 120 x 100 x 15 cm

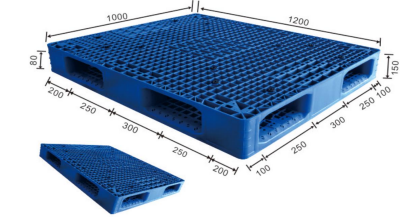

WEIGHT ± 5%	19.5 kg			
LOAD CAPACITY				
	6 T	1.5 T	0.5 T	
CONTAINER	20FT	150	40HC	367

ENL-Y1212WSA 120 x 120 x 15 cm

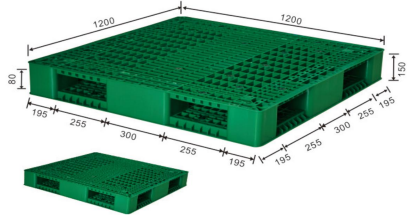

WEIGHT ± 5%	23.0 kg			
LOAD CAPACITY				
	6 T	1.5 T	0.5 T	
CONTAINER	20FT	120	40HC	310

ENL-Y1311WSA 130 x 110 x 15 cm

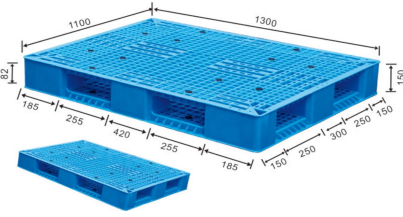

WEIGHT ± 5%	24.0 kg			
LOAD CAPACITY				
	6 T	1.5 T	0.5 T	
CONTAINER	20FT	125	40HC	310

ENL-Y1411WSB 140 x 110 x 15 cm

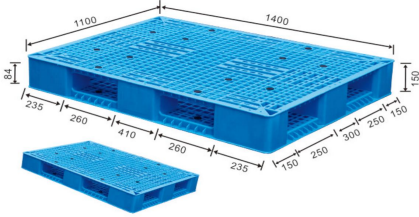

WEIGHT ± 5%	25.4 kg			
LOAD CAPACITY				
	6 T	1.5 T	0.5 T	
CONTAINER	20FT	115	40HC	280

ENL-Y1411WSA 140 x 110 x 15 cm

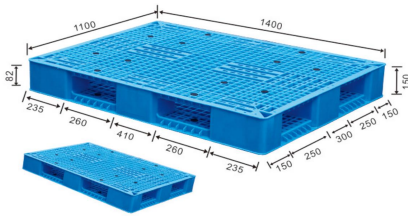

WEIGHT ± 5%	30.5 kg			
LOAD CAPACITY				
	6 T	1.5 T	0.5 T	
CONTAINER	20FT	115	40HC	280

ENL-Y1412WSB 140 x 120 x 15 cm

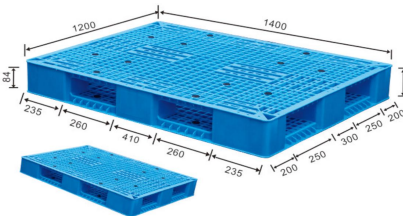

WEIGHT ± 5%	27.0 kg			
LOAD CAPACITY				
	6 T	1.5 T	0.5 T	
CONTAINER	20FT	105	40HC	272

GRID SURFACE | REVERSIBLE

WELDED

RACKABLE

STACKABLE



ENL-H1010WSA/B 100 x 100 x 16/15 cm

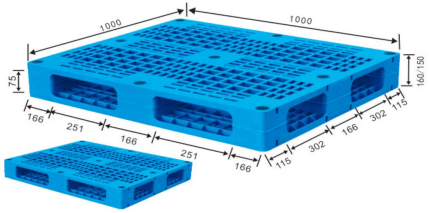

WEIGHT ± 5%	15.0 kg	22.0 kg	(8 BARS)
LOAD CAPACITY			
CONTAINER	20FT	180	40HC 450

ENL-H1109WSA/B 110 x 90 x 16/15 cm

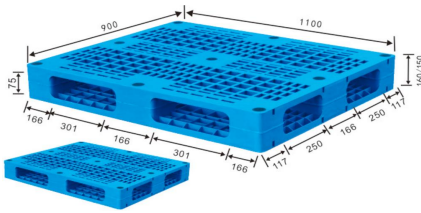

WEIGHT ± 5%	14.6 kg	19.6 kg	(8 BARS)
LOAD CAPACITY			
CONTAINER	20FT	180	40HC 446

ENL-H1111WSE 110 x 110 x 15 cm

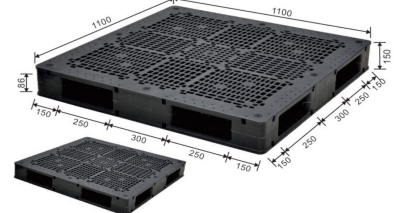

WEIGHT ± 5%	18.4 kg	25.4 kg	(8 BARS)
LOAD CAPACITY			
CONTAINER	20FT	140	40HC 362

ENL-H1208WSA 120 x 80 x 15 cm

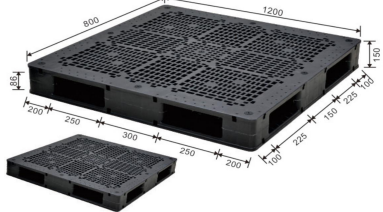

WEIGHT ± 5%	coming soon		
LOAD CAPACITY			
CONTAINER	20FT	150	40HC 375

ENL-H1210WSF 120 x 100 x 15 cm

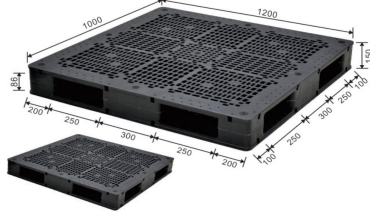

WEIGHT ± 5%	18.6 kg	24.6 kg	(12 BARS)
LOAD CAPACITY			
CONTAINER	20FT	150	40HC 367

ENL-H1211WSB 120 x 110 x 15 cm

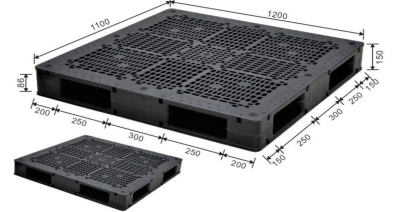

WEIGHT ± 5%	19.4 kg	27.4 kg	(12 BARS)
LOAD CAPACITY			
CONTAINER	20FT	140	40HC 340

ENL-H1212WSE 120 x 120 x 15 cm

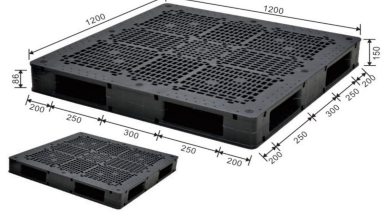

WEIGHT ± 5%	21.0 kg	29.0 kg	(12 BARS)
LOAD CAPACITY			
CONTAINER	20FT	120	40HC 310

ENL-H125112WSA 125 x 112 x 14 cm

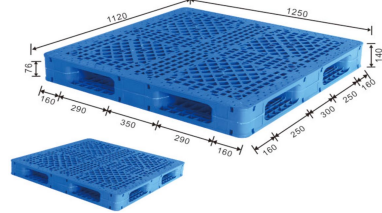

WEIGHT ± 5%	22.0 kg	30.0 kg	(12 BARS)
LOAD CAPACITY			
CONTAINER	20FT	120	40HC 310

ENL-H1310WSA 130 x 100 x 15 cm

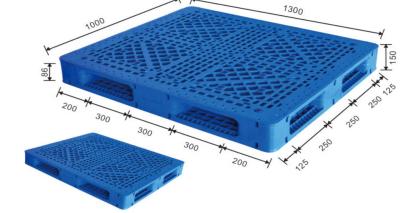

WEIGHT ± 5%	23.0 kg	31.0 kg	(12 BARS)
LOAD CAPACITY			
CONTAINER	20FT	145	40HC 358

ENL-H1311WSF 130 x 110 x 15 cm

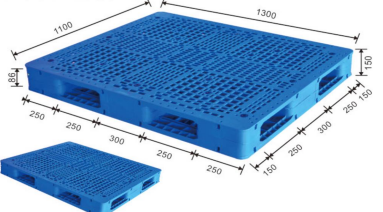

WEIGHT ± 5%	21.7 kg	29.7 kg	(12 BARS)
LOAD CAPACITY			
CONTAINER	20FT	120	40HC 310

ENL-H1411WSC 140 x 110 x 15 cm

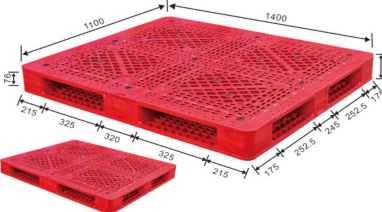

WEIGHT ± 5%	27.2 kg	36.2 kg	(20 BARS)
LOAD CAPACITY			
CONTAINER	20FT	115	40HC 280

ENL-H1412WSD 140 x 120 x 15 cm

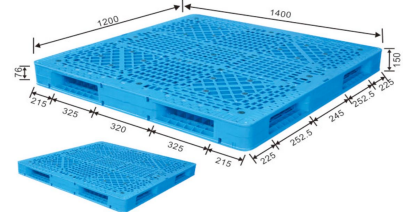

WEIGHT ± 5%	29.0 kg	38.0 kg	(20 BARS)
LOAD CAPACITY			
CONTAINER	20FT	105	40HC 272

GRID SURFACE | REVERSIBLE

WELDED

RACKABLE

STACKABLE



ENL-H1414WSC 140 x 140 x 15 cm

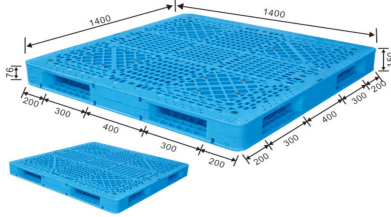

WEIGHT ± 5%	31.4 kg	40.4 kg (20 BARS)		
LOAD CAPACITY	6 T	1.5 T	1 T	
CONTAINER	20FT	77	40HC	189

ENL-H1512WSB 150 x 120 x 15 cm

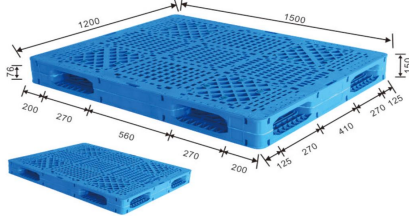

WEIGHT ± 5%	31.3 kg	40.3 kg (20 BARS)		
LOAD CAPACITY	6 T	1.5 T	1 T	
CONTAINER	20FT	100	40HC	250

ENL-H1513WSA 150 x 130 x 15 cm

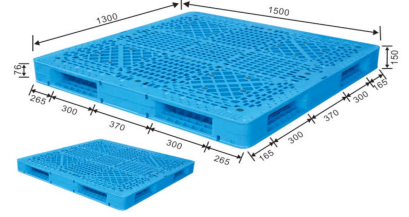

WEIGHT ± 5%	33.2 kg	42.2 kg (20 BARS)		
LOAD CAPACITY	6 T	1.5 T	1 T	
CONTAINER	20FT	95	40HC	232

ENL-H1515WSA 150 x 150 x 15 cm

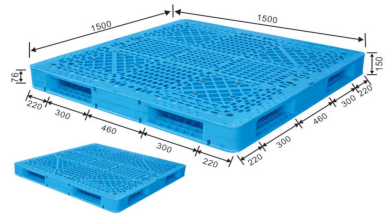

WEIGHT ± 5%	37.0 kg	49.0 kg (20 BARS)		
LOAD CAPACITY	6 T	1.5 T	1 T	
CONTAINER	20FT	70	40HC	174

ENL-H1550WSA 155 x 155 x 15.4 cm

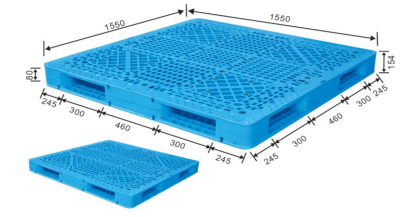

WEIGHT ± 5%	38.8 kg	50.8 kg (20 BARS)		
LOAD CAPACITY	6 T	1.5 T	1 T	
CONTAINER	20FT	70	40HC	174

ENL-H1614WSB 160 x 140 x 15 cm

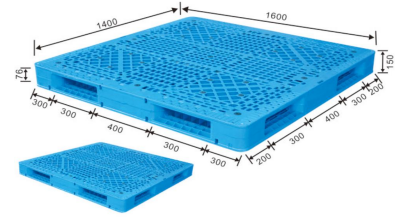

WEIGHT ± 5%	37.0 kg	49.0 kg (20 BARS)		
LOAD CAPACITY	6 T	1.5 T	1 T	
CONTAINER	20FT	67	40HC	166

ENL-1616WSA 160 x 160 x 15 cm

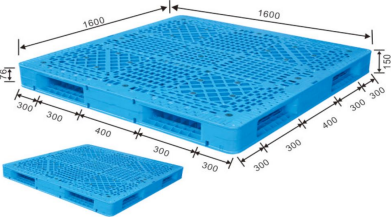

WEIGHT ± 5%	43.4 kg	55.4 kg (20 BARS)		
LOAD CAPACITY	6 T	1.5 T	1 T	
CONTAINER	20FT	62	40HC	152

FLAT SURFACE | REVERSIBLE

WELDED

RACKABLE

STACKABLE



ENL-H1008PSA 100 x 80 x 16 cm

WEIGHT ± 5%	14.5 kg	20.0 kg	(8 BARS)
LOAD CAPACITY	6 T	1.5 T	1T
CONTAINER	20FT	180	40HC 456

ENL-H1008PSB 100 x 80 x 15 cm

WEIGHT ± 5%	14.5 kg	20.0 kg	(8 BARS)
LOAD CAPACITY	6 T	1.5 T	1T
CONTAINER	20FT	180	40HC 456

ENL-H1010PSA 100 x 100 x 16 cm

WEIGHT ± 5%	16.0 kg	21.5 kg	(8 BARS)
LOAD CAPACITY	6 T	1.5 T	1T
CONTAINER	20FT	180	40HC 456

ENL-H1010PSB 100 x 100 x 15 cm

WEIGHT ± 5%	16.0 kg	21.5 kg	(8 BARS)
LOAD CAPACITY	6 T	1.5 T	1T
CONTAINER	20FT	180	40HC 456

ENL-H1109PSA 110 x 90 x 16 cm

WEIGHT ± 5%	17.0 kg	23.0 kg	(8 BARS)
LOAD CAPACITY	6 T	1.5 T	1T
CONTAINER	20FT	180	40HC 446

ENL-H1109PSB 110 x 90 x 15 cm

WEIGHT ± 5%	17.0 kg	23.0 kg	(8 BARS)
LOAD CAPACITY	6 T	1.5 T	1T
CONTAINER	20FT	180	40HC 446

ENL-H1111PSE 110 x 110 x 15 cm

WEIGHT ± 5%	20.0 kg	27.0 kg	(12 BARS)
LOAD CAPACITY	6 T	1.5 T	1T
CONTAINER	20FT	140	40HC 362

ENL-H1208PSB 120 x 80 x 15 cm

WEIGHT ± 5%	coming soon		
LOAD CAPACITY	6 T	1.5 T	1T
CONTAINER	20FT	150	40HC 375

ENL-H1210PSF 120 x 100 x 15 cm

WEIGHT ± 5%	20.2 kg	26.2 kg	(12 BARS)
LOAD CAPACITY	6 T	1.5 T	1T
CONTAINER	20FT	150	40HC 367

ENL-H1211PSB 120 x 110 x 15 cm

WEIGHT ± 5%	21.6 kg	29.6 kg	(12 BARS)
LOAD CAPACITY	6 T	1.5 T	1T
CONTAINER	20FT	140	40HC 340

ENL-H1212PSE 120 x 120 x 15 cm

WEIGHT ± 5%	23.0 kg	31.0 kg	(12 BARS)
LOAD CAPACITY	6 T	1.5 T	1T
CONTAINER	20FT	120	40HC 280

ENL-H1310PSA 130 x 100 x 15 cm

WEIGHT ± 5%	26.1 kg	34.1 kg	(12 BARS)
LOAD CAPACITY	6 T	1.5 T	1T
CONTAINER	20FT	145	40HC 358

FLAT SURFACE | REVERSIBLE

WELDED

RACKABLE

STACKABLE

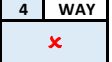

ENL-H1311PSG 130 x 110 x 15 cm

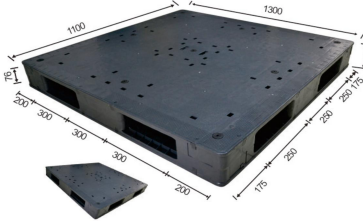

WEIGHT ± 5%	26.5 kg	34.5 kg (12 BARS)		
LOAD CAPACITY	6 T	1.5 T	1T	
CONTAINER	20FT	125	40HC	310

ENL-H1411PSD 140 x 110 x 15 cm

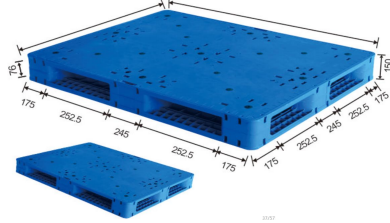

WEIGHT ± 5%	29.1 kg	38.1 kg (20 BARS)		
LOAD CAPACITY	6 T	1.5 T	1T	
CONTAINER	20FT	115	40HC	280

ENL-H1412PSC 140 x 120 x 15 cm

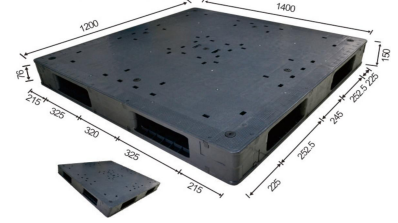

WEIGHT ± 5%	31.6 kg	39.6 kg (20 BARS)		
LOAD CAPACITY	6 T	1.5 T	1T	
CONTAINER	20FT	105	40HC	272

ENL-H1414PSA 140 x 140 x 16 cm

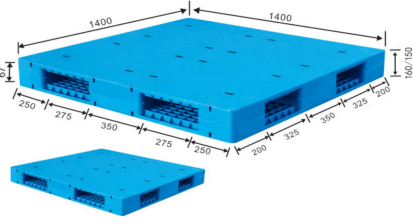

WEIGHT ± 5%	39.2 kg	47.2 kg (20 BARS)		
LOAD CAPACITY	6 T	1.5 T	1T	
CONTAINER	20FT	77	40HC	189

ENL-H1414PSB 140 x 140 x 15 cm

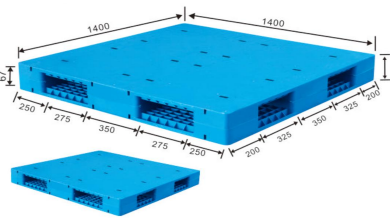

WEIGHT ± 5%	39.2 kg	47.2 kg (20 BARS)		
LOAD CAPACITY	6 T	1.5 T	1T	
CONTAINER	20FT	77	40HC	189

ENL-H1512PSB 150 x 120 x 15 cm

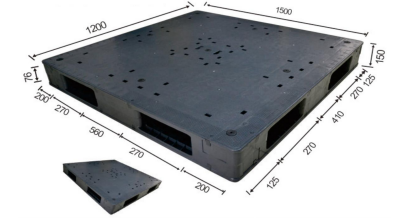

WEIGHT ± 5%	36.6 kg	45.6 kg (20 BARS)		
LOAD CAPACITY	6 T	1.5 T	1T	
CONTAINER	20FT	100	40HC	250

ENL-H1513PSA 150 x 130 x 15 cm

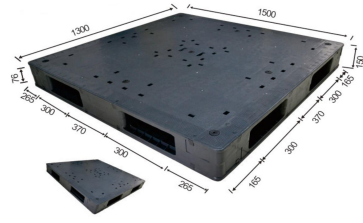

WEIGHT ± 5%	38.4 kg	47.4 kg (20 BARS)		
LOAD CAPACITY	6 T	1.5 T	1T	
CONTAINER	20FT	100	40HC	250

ENL-H1614PSA 160 x 140 x 15 cm

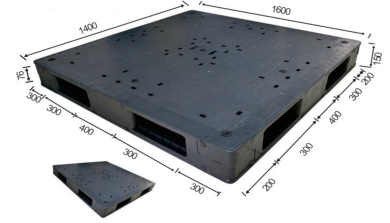

WEIGHT ± 5%	coming soon			
LOAD CAPACITY	6 T	1.5 T	1T	
CONTAINER	20FT	67	40HC	166

SPILL PALLETS

ONE TIME ROTOMOULD

GROUND USE

STACKABLE



ENL-1 DRUM 68 x 68 x 15 cm



WEIGHT ± 5%	8.0 kg	VOLUME	43 L
LOAD CAPACITY			
	0.7 T	0.3 T	X
CONTAINER	20FT 480	40HC	1120

ENL-2 DRUMS 132 x 68 x 15 cm



WEIGHT ± 5%	17.0 kg	VOLUME	80 L
LOAD CAPACITY			
	1.3 T	0.6 T	X
CONTAINER	20FT 240	40HC	560

ENL-2 DRUMS 132 x 68 x 30 cm



WEIGHT ± 5%	22.0 kg	VOLUME	120 L
LOAD CAPACITY			
	1.3 T	0.6 T	X
CONTAINER	20FT 240	40HC	560

ENL-2 DRUMS 132x70x45 cm



WEIGHT ± 5%	25.0 kg	VOLUME	150 L
LOAD CAPACITY			
	3 T	1.3 T	X
CONTAINER	20FT 150	40HC	380

ENL-4 DRUMS 132 x 132 x 15 cm



WEIGHT ± 5%	32.0 kg	VOLUME	150 L
LOAD CAPACITY			
	3 T	1.3 T	X
CONTAINER	20FT 120	40HC	290

ENL-4 DRUMS 132 x 132 x 30 cm



WEIGHT ± 5%	36.0 kg	VOLUME	220 L
LOAD CAPACITY			
	3 T	1.3 T	X
CONTAINER	20FT 104	40HC	234

ENL- IBC 160x160x70 cm



WEIGHT ± 5%	95kg		
LOAD CAPACITY			
	6T	3 T	X
CONTAINER	20FT 40	40HC	100

ENL- IBC 138x138x90 cm



WEIGHT ± 5%	95kg		
LOAD CAPACITY			
	6T	3 T	X
CONTAINER	20FT 40	40HC	100

ENL-DOUBLE IBC 220x130x50 cm



WEIGHT ± 5%	95kg		
LOAD CAPACITY			
	6 T	3 T	X
CONTAINER	20FT 40	40HC	100

ENL- IBC 160x160x70 cm



WEIGHT ± 5%	95kg		
LOAD CAPACITY			
	3 T	6 T	X
CONTAINER	20FT 40	40HC	100

ENL-RAMP 120 x 80 x 30 cm



WEIGHT ± 5%	22kg		
LOAD CAPACITY			
	1.3 T	0.6 T	X
CONTAINER	20FT 80	40HC	240

ENL-RAMP 120 x 80 x 15 cm



WEIGHT ± 5%	17kg		
LOAD CAPACITY			
	1.3 T	0.6 T	X
CONTAINER	20FT 80	40HC	240

SPILL PALLETS

ONE TIME ROTOMOULD

GROUND USE

STACKABLE



PLASTIC DRUM RACK 97x80x52 cm



WEIGHT ± 5%	20kg			
LOAD CAPACITY				
	3 T	1.3 T	X	
CONTAINER	20FT	67	40HC	175

DRUM CART 77x77x112 cm



WEIGHT ± 5%	8kg		
LOAD CAPACITY			
	3 T	1.3 T	X
CONTAINER	20FT		40HC

DRUM DOLLY WITH HANDLE 135x65x35 cm



WEIGHT ± 5%	40kg			
LOAD CAPACITY				
	3 T	1.3 T	X	
CONTAINER	20FT	79	40HC	180

PLASTIC CABINET 49x49x100 cm



WEIGHT ± 5%	22kg			
LOAD CAPACITY				
	3 T	1.3 T	X	
CONTAINER	20FT	88	40HC	240

PLASTIC CABINET 90x60x50 cm



WEIGHT ± 5%	15kg		
LOAD CAPACITY			
	3 T	1.3 T	X
CONTAINER	20FT	80	40HC

PLASTIC CABINET 105x50x50 cm



WEIGHT ± 5%	24kg			
LOAD CAPACITY				
	3 T	1.3 T	X	
CONTAINER	20FT		40HC	

HARD COVERD SPILL PALLET 149x99x169 cm



WEIGHT ± 5%	95kg			
LOAD CAPACITY				
	3 T	1.3 T	X	
CONTAINER	20FT		40HC	

SALVAGE DRUM 20/30/65/95 GALLON



WEIGHT ± 5%	5.5kg/9.5kg/18kg		
LOAD CAPACITY			
	3 T	1.3 T	X
CONTAINER	20FT		40HC

SALVAGE DRUM 65/95 GALLON



WEIGHT ± 5%	21kg/25kg			
LOAD CAPACITY				
	3 T	1.3 T	X	
CONTAINER	20FT		40HC	

WATER BOTTLES PALLETS

ONE TIME INJECTION

GROUND USE

STACKABLE



4 WAY
✓



4 WAY
✓

WATER RACK 5 GALLON 4 LAYERS



WEIGHT ± 5%	102.7kg			
LOAD CAPACITY				
	4 T	1 T	X	
CONTAINER	20FT	18	40HC	44

ENL-12 bottle pallet 108 x 81 x 17 cm



WEIGHT ± 5%	13.5kg		
LOAD CAPACITY			
	4 T	1 T	X
CONTAINER	20FT	200	40HC

ENL-16 bottle pallet 108 x 108 x 18 cm



WEIGHT ± 5%	17kg			
LOAD CAPACITY				
	4 T	1 T	X	
CONTAINER	20FT	150	40HC	380

PALLET CONTAINERS



ENL-1210A	75 kg	120 x 100 x 97.5 cm																																
<table border="1"> <tr><td>STATIC</td><td>4 T</td></tr> <tr><td>DYN</td><td>1 T</td></tr> </table>			STATIC	4 T	DYN	1 T																												
STATIC	4 T																																	
DYN	1 T																																	
<table border="1"> <tr> <td>Internal Dim</td> <td>111 x 91 x 79 cm</td> <td>Collapsible High</td> <td>40.6 cm</td> </tr> <tr> <td colspan="4">FOLDED</td> </tr> <tr> <td colspan="4">W/LID</td> </tr> <tr> <td>40HC</td> <td>150</td> <td>132</td> <td></td> </tr> <tr> <td>OPEN</td> <td>44</td> <td></td> <td></td> </tr> <tr> <td colspan="4">20FT</td> </tr> <tr> <td>40HC</td> <td>56</td> <td>52</td> <td></td> </tr> <tr> <td>OPEN</td> <td>20</td> <td></td> <td></td> </tr> </table>			Internal Dim	111 x 91 x 79 cm	Collapsible High	40.6 cm	FOLDED				W/LID				40HC	150	132		OPEN	44			20FT				40HC	56	52		OPEN	20		
Internal Dim	111 x 91 x 79 cm	Collapsible High	40.6 cm																															
FOLDED																																		
W/LID																																		
40HC	150	132																																
OPEN	44																																	
20FT																																		
40HC	56	52																																
OPEN	20																																	

ENL-1210B	66 kg	120 x 100 x 97.5 cm																																
<table border="1"> <tr><td>STATIC</td><td>4 T</td></tr> <tr><td>DYN</td><td>1 T</td></tr> </table>			STATIC	4 T	DYN	1 T																												
STATIC	4 T																																	
DYN	1 T																																	
<table border="1"> <tr> <td>Internal Dim</td> <td>111 x 91 x 79 cm</td> <td>Collapsible High</td> <td>40.6 cm</td> </tr> <tr> <td colspan="4">FOLDED</td> </tr> <tr> <td colspan="4">W/LID</td> </tr> <tr> <td>40HC</td> <td>150</td> <td>132</td> <td></td> </tr> <tr> <td>OPEN</td> <td>44</td> <td></td> <td></td> </tr> <tr> <td colspan="4">20FT</td> </tr> <tr> <td>40HC</td> <td>56</td> <td>52</td> <td></td> </tr> <tr> <td>OPEN</td> <td>20</td> <td></td> <td></td> </tr> </table>			Internal Dim	111 x 91 x 79 cm	Collapsible High	40.6 cm	FOLDED				W/LID				40HC	150	132		OPEN	44			20FT				40HC	56	52		OPEN	20		
Internal Dim	111 x 91 x 79 cm	Collapsible High	40.6 cm																															
FOLDED																																		
W/LID																																		
40HC	150	132																																
OPEN	44																																	
20FT																																		
40HC	56	52																																
OPEN	20																																	

ENL-1210B2	57 kg	120 x 100 x 97.5 cm																																
<table border="1"> <tr><td>STATIC</td><td>4 T</td></tr> <tr><td>DYN</td><td>1 T</td></tr> </table>			STATIC	4 T	DYN	1 T																												
STATIC	4 T																																	
DYN	1 T																																	
<table border="1"> <tr> <td>Internal Dim</td> <td>112 x 92 x 79.5 cm</td> <td>Collapsible High</td> <td>40.6 cm</td> </tr> <tr> <td colspan="4">FOLDED</td> </tr> <tr> <td colspan="4">W/LID</td> </tr> <tr> <td>40HC</td> <td>148</td> <td>132</td> <td></td> </tr> <tr> <td>OPEN</td> <td>44</td> <td></td> <td></td> </tr> <tr> <td colspan="4">20FT</td> </tr> <tr> <td>40HC</td> <td>56</td> <td>52</td> <td></td> </tr> <tr> <td>OPEN</td> <td>20</td> <td></td> <td></td> </tr> </table>			Internal Dim	112 x 92 x 79.5 cm	Collapsible High	40.6 cm	FOLDED				W/LID				40HC	148	132		OPEN	44			20FT				40HC	56	52		OPEN	20		
Internal Dim	112 x 92 x 79.5 cm	Collapsible High	40.6 cm																															
FOLDED																																		
W/LID																																		
40HC	148	132																																
OPEN	44																																	
20FT																																		
40HC	56	52																																
OPEN	20																																	

ENL-1210C	47 kg	120 x 100 x 59 cm																																
<table border="1"> <tr><td>STATIC</td><td>4 T</td></tr> <tr><td>DYN</td><td>1 T</td></tr> </table>			STATIC	4 T	DYN	1 T																												
STATIC	4 T																																	
DYN	1 T																																	
<table border="1"> <tr> <td>Internal Dim</td> <td>111 x 91 x 40.5 cm</td> <td>Collapsible High</td> <td>40.6 cm</td> </tr> <tr> <td colspan="4">FOLDED</td> </tr> <tr> <td colspan="4">W/LID</td> </tr> <tr> <td>40HC</td> <td>150</td> <td>132</td> <td></td> </tr> <tr> <td>OPEN</td> <td>44</td> <td></td> <td></td> </tr> <tr> <td colspan="4">20FT</td> </tr> <tr> <td>40HC</td> <td>56</td> <td>52</td> <td></td> </tr> <tr> <td>OPEN</td> <td>20</td> <td></td> <td></td> </tr> </table>			Internal Dim	111 x 91 x 40.5 cm	Collapsible High	40.6 cm	FOLDED				W/LID				40HC	150	132		OPEN	44			20FT				40HC	56	52		OPEN	20		
Internal Dim	111 x 91 x 40.5 cm	Collapsible High	40.6 cm																															
FOLDED																																		
W/LID																																		
40HC	150	132																																
OPEN	44																																	
20FT																																		
40HC	56	52																																
OPEN	20																																	

ENL-1210D	55 kg	120 x 100 x 100 cm																																
<table border="1"> <tr><td>STATIC</td><td>4 T</td></tr> <tr><td>DYN</td><td>1 T</td></tr> </table>			STATIC	4 T	DYN	1 T																												
STATIC	4 T																																	
DYN	1 T																																	
<table border="1"> <tr> <td>Internal Dim</td> <td>111.7 x 91.8 x 86.5 cm</td> <td>Collapsible High</td> <td>36 cm</td> </tr> <tr> <td colspan="4">FOLDED</td> </tr> <tr> <td colspan="4">W/LID</td> </tr> <tr> <td>40HC</td> <td>150</td> <td>137</td> <td></td> </tr> <tr> <td>OPEN</td> <td>44</td> <td></td> <td></td> </tr> <tr> <td colspan="4">20FT</td> </tr> <tr> <td>40HC</td> <td>60</td> <td>52</td> <td></td> </tr> <tr> <td>OPEN</td> <td>20</td> <td></td> <td></td> </tr> </table>			Internal Dim	111.7 x 91.8 x 86.5 cm	Collapsible High	36 cm	FOLDED				W/LID				40HC	150	137		OPEN	44			20FT				40HC	60	52		OPEN	20		
Internal Dim	111.7 x 91.8 x 86.5 cm	Collapsible High	36 cm																															
FOLDED																																		
W/LID																																		
40HC	150	137																																
OPEN	44																																	
20FT																																		
40HC	60	52																																
OPEN	20																																	

ENL-Sleeve Box	Nestable	CUSTOMIED SIZE																
<table border="1"> <tr><td>STATIC</td><td>4 T</td></tr> <tr><td>DYN</td><td>1 T</td></tr> </table>			STATIC	4 T	DYN	1 T												
STATIC	4 T																	
DYN	1 T																	
<table border="1"> <tr> <td>External Size mm</td> <td>Internal Size mm</td> <td>Material</td> <td>Lock</td> </tr> <tr> <td>1150x1150</td> <td>1100x1100</td> <td>HDPE+PP</td> <td>Yes</td> </tr> <tr> <td>1200x800</td> <td>1150x750</td> <td>HDPE+PP</td> <td>Yes</td> </tr> <tr> <td>1200x1000</td> <td>1135x935</td> <td>HDPE+PP</td> <td>Yes</td> </tr> </table>			External Size mm	Internal Size mm	Material	Lock	1150x1150	1100x1100	HDPE+PP	Yes	1200x800	1150x750	HDPE+PP	Yes	1200x1000	1135x935	HDPE+PP	Yes
External Size mm	Internal Size mm	Material	Lock															
1150x1150	1100x1100	HDPE+PP	Yes															
1200x800	1150x750	HDPE+PP	Yes															
1200x1000	1135x935	HDPE+PP	Yes															

PALLET CONTAINERS



4	WAY
✓	



4	WAY
✓	

ENL-1210WE

43 kg

120 x 100 x 81 cm

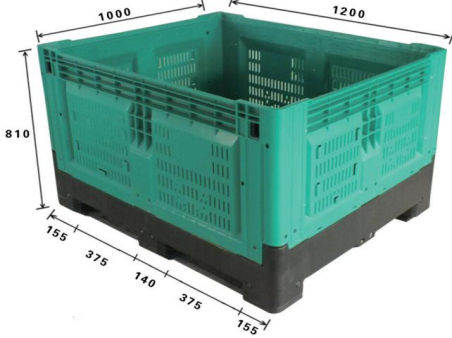

STATIC
4 T

DYN
1 T

ENL-1210FE

45 kg

120 x 100 x 81 cm

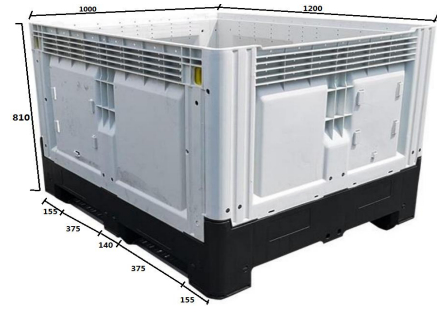

STATIC
4 T

DYN
1 T

Internal Dim 111 x 91 x 66 cm Collapsible High 29 cm

FOLDED OPEN	40HC	W/LID		FOLDED OPEN	20FT	W/LID	
		210	175			83	60
		60				24	

Internal Dim 111 x 91 x 66 cm Collapsible High 29 cm

FOLDED OPEN	40HC	W/LID		FOLDED OPEN	20FT	W/LID	
		210	175			83	60
		60				24	

ENL-1162W

49 kg

116 x 116 x 79 cm

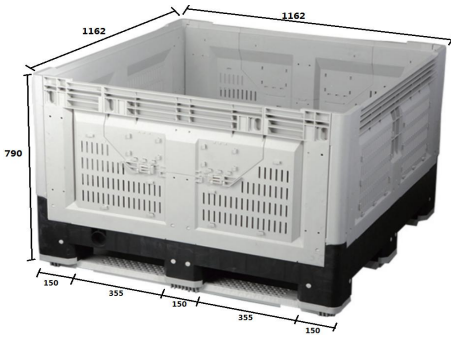

STATIC
4 T

DYN
1 T

ENL-1162F

52 kg

116 x 116 x 79 cm

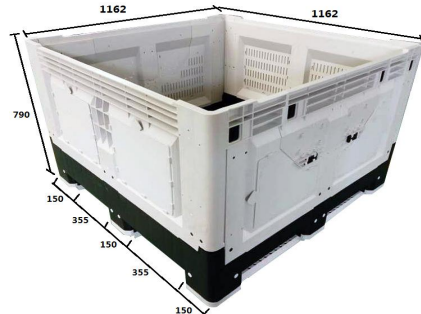

STATIC
4 T

DYN
1 T

Internal Dim 109 x 109 x 63 cm Collapsible High 30 cm

FOLDED OPEN	40HC	W/LID		FOLDED OPEN	20FT	W/LID	
		180	168			80	72
		60				30	

Internal Dim 109 x 109 x 63 cm Collapsible High 30 cm

FOLDED OPEN	40HC	W/LID		FOLDED OPEN	20FT	W/LID	
		180	168			80	72
		60				30	

ENL-1210WK

32 kg

120 x 100 x 76 cm

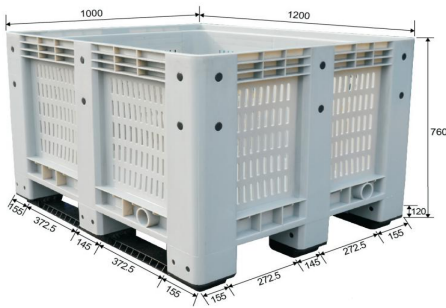

STATIC
4 T

DYN
1 T

ENL-1210FK

34 kg

120 x 100 x 76 cm

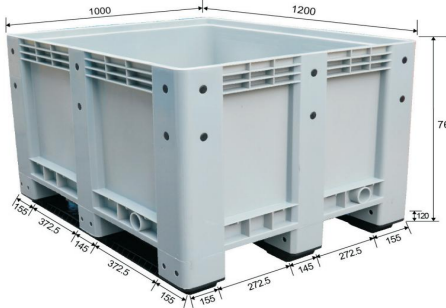

STATIC
4 T

DYN
1 T

Internal Dim 111 x 91 x 60 cm

OVERLAP STACK	40HC	W/LID		OVERLAP STACK	20FT	W/LID	
		104	104			44	44
		60				24	

Internal Dim 111 x 91 x 60 cm

OVERLAP STACK	40HC	W/LID		OVERLAP STACK	20FT	W/LID	
		104	104			44	44
		60				24	

PLASTIC WASTE BINS

1100A



VOLUME	1100 L			
SIZE	135 x 104 x 130 CM			
WEIGHT ± 5%	50 KG			
THICKNESS	BODY	7 MM	LID	4 MM
CONTAINER	20FT	36	40HC	120

660B-3



VOLUME	660 L			
SIZE	137 x 78 x 121 CM			
WEIGHT ± 5%	44 KG			
THICKNESS	BODY	6 MM	LID	4 MM
CONTAINER	20FT	60	40HC	138

400A-1A



VOLUME	400 L			
SIZE	125 x 82 x 92 CM			
WEIGHT ± 5%	31 KG			
THICKNESS	BODY	5 MM	LID	4 MM
CONTAINER	20FT	140	40HC	350



CODE	VOLUME	SIZE	WEIGHT	THICKNESS	20FT / 40HQ
360A-2	360 L	70 x 74 x 112 CM	21 KG	5.5 MM	210 PCS / 450 PCS
240V-23	240 L	58 x 65 x 107 CM	12.6 KG	4.5 MM	350 PCS / 900 PCS
180A-1	180 L	67 x 55 x 100 CM	11.4 KG	4.0 MM	352 PCS / 901 PCS
140G-1	140 L	52 x 54 x 95 CM	8.1 KG	3.5 MM	350 PCS / 820 PCS
120V-14	120 L	48 x 57 x 95 CM	7.6 KG	3 MM	580 PCS / 1400 PCS
100G-14	100 L	47 x 48 x 82 CM	6.7 KG	3 MM	650 PCS / 1600 PCS
80F-14	80 L	48 x 48 x 68 CM	5.8 KG	3 MM	600 PCS / 1600 PCS



CODE	VOLUME	SIZE	WEIGHT	THICKNESS	20FT / 40HQ
240U-14	240 L	74 x 58 x 108 CM	14.5 KG	4.5 MM	235 PCS / 650 PCS
120U-14	120 L	56 x 48 x 98 CM	9.1 KG	3.5 MM	370 PCS / 900 PCS
100U-14	100 L	56 x 48 x 85 CM	8.0 KG	3.0 MM	370 PCS / 900 PCS



CODE	VOLUME	SIZE	WEIGHT	THICKNESS	20FT / 40HQ
100k-18	100 L	49 x 48 x 84 CM	4.8 KG	2.5 MM	490 PCS / 1190 PCS
100k-7	80 L	49 x 43 x 70 CM	3.9 KG	2.5 MM	570 PCS / 1400 PCS
50K-7	50 L	43 x 40 x 60 CM	2.9 KG	2.0 MM	800 PCS / 1950 PCS
30K-7	30 L	43 x 40 x 44 CM	2.2 KG	2.0 MM	1020 PCS / 2500 PCS
15K-7	15 L	27 x 26 x 34 CM	1.0 KG	1.5 MM	2800 PCS / 6200 PCS

FOLDABLE PLASTIC CRATE - VEGETABLE & FRUITS

FOLDABLE

A



B



MATERIAL : PP TEMP : (-40 TO 70) C°

PROCESSING : ONE TIME INJECTION

STD COLORS



RFID
✓

No	CODE	EXTERNAL SIZE (± 3%)	WEIGHT ± 5%	INTERANL SIZE (± 3%)	VOL	CAPCITY	LOADING		
							20FT	40HQ	
1	403014W	A	40 x 30 x 14 cm	0.9 kg	36.6 x 26.6 x 12.8 cm	12 L	15 kg	4452	10800
2	403017W	A	40 x 30 x 17 cm	1 kg	36.5 x 26.5 x 15 cm	14.5 L	15 kg	4452	10800
3	403022W	A	40 x 30 x 22 cm	1.2 kg	36 x 26 x 19.7 cm	18.5 L	15 kg	4452	10800
4	604012W	A	60 x 40 x 12 cm	1.4 kg	56 x 36 x 10.5 cm	21 L	25 kg	2650	6480
5	604014W	A	60 x 40 x 14 cm	1.5 kg	56 x 36 x 12 cm	24 L	25 kg	2226	5400
6	604018W	A & B	60 x 40 x 18 cm	1.8 kg	56 x 36 x 16 cm	32 L	30 kg	2226	5400
7	604022W	A & B	60 x 40 x 22 cm	2 kg	56 x 36 x 20 cm	40 L	30 kg	3240	7875
8	604026W	A & B	60 x 40 x 26 cm	2.28 kg	56 x 36 x 24.5 cm	50 L	30 kg	2226	5400
9	604030W	A & B	60 x 40 x 30 cm	2.29 kg	56 x 36 x 27.5 cm	55 L	45 kg	2160	5250
10	604034W	A & B	60 x 40 x 34 cm	2.5 kg	56 x 36 x 32 cm	64 L	45 kg	2160	5250
11	533631C	A	53.5 x 36 x 31.2 cm	2.3 kg	50.3 x 32.3 x 28.5 cm	46 L	40 kg	1750	4250
12	605017W	A	60 x 50 x 17 cm	1.9 kg	56 x 46 x 15 cm	38 L	45 kg	1080	2880
13	605034W	A	60 x 60 x 34 cm	3.1 kg	56 x 46 x 32 cm	82 L	45 kg	1080	2880
14	6333257W	A	63 x 33 x 24.7 cm	1.9 kg	60.5 x 30.5 x 23.7 cm	44 L	45 kg	1000	2500
15	633337W	A	63 x 33 x 37 cm	2.8 kg	60 x 30 x 35.9 cm	64.5 L	45 kg	1000	2500
16	805850W		80 x 58 x 50 cm	6.19 kg	75 x 52.5 x 48.5 cm	190 L	80 kg	533	1296

FOLDABLE PLASTIC BOX - HOUSEHOLD

FOLDABLE



MATERIAL : PP TEMP : (-40 TO 70) C°

PROCESSING : ONE TIME INJECTION

STD COLORS



RFID
✓

No	CODE	EXTERNAL SIZE (± 3%)	WEIGHT ± 5%	INTERANL SIZE (± 3%)	VOL	CAPCITY	LOADING		
							20FT	40HQ	
1	362627W		36 x 26 x 27 cm	1.2 kg	33 x 23 x 26 cm	20 L	20 kg	3100	7500
2	422823W		41.8 x 28.5 x 23 cm	0.9 kg	38.5 x 25.8 x 21.5 cm	21 L	20 kg	2850	6912
3	5336295W		53 x 36 x 29.5 cm	1.6 kg	49.3 x 32.5 x 28.5 cm	46 L	30 kg	1300	3150
4	533624W		53 x 36 x 24 cm	2.1 kg	49 x 33.7 x 22 cm	36 L	30 kg	1300	3150
5	5336326W		53 x 36 x 32.6 cm	2.4 kg	49 x 33.7 x 31 cm	63 L	40 kg	1300	3150
6	5336365W		53 x 36 x 36.5 cm	2 kg	49 x 33.7 x 36 cm	58 L	30 kg	1300	3150
7	6544345W		65 x 44 x 34.5 cm	3.2 kg	61 x 40 x 33 cm	80 L	40 kg	1270	3090
8	604035W		60 x 40 x 34.5 cm	2.8 kg	56 x 36 x 33 cm	66 L	30 kg	1400	3456

FOLDABLE PLASTIC BOX - LOGISTIC STORAGE

FOLDABLE



MATERIAL : PP

TEMP : (-40 TO 70) C°

PROCESSING : ONE TIME INJECTION

STD COLORS



RFID



No	CODE	EXTERNAL SIZE (± 3%)	WEIGHT ± 5%	INTERANL SIZE (± 3%)	VOL	CAPACITY	LOADING	
							20FT	40HQ
1	400-148	40 x 30 x 14.8 cm	1.3 kg	36.5 x 26.5 x 14 cm	13 L	20 kg	2800	6900
2	400-170	40 x 30 x 17 cm	1.25 kg	36.5 x 26.5 x 16 cm	15 L	20 kg	2800	6900
3	400-230	40 x 30 x 23 cm	1.5 kg	36.5 x 26.5 x 22 cm	21 L	20 kg	2800	6900
4	400-280	40 x 30 x 28 cm	2.1 kg	36.5 x 26.5 x 27 cm	26 L	30 kg	2800	6900
5	500-180	53 x 41 x 18 cm	2 kg	50 x 38 x 17 cm	32 L	30 kg	1700	4200
6	500-240	53 x 41 x 24 cm	2.3 kg	50 x 38 x 23 cm	44 L	35 kg	1700	4200
7	500-300	53 x 41 x 30 cm	2.6 kg	50 x 38 x 29 cm	55 L	40 kg	1700	4200
8	600-150	60 x 40 x 14.8 cm	2 kg	56.5 x 36.5 x 14 cm	28 L	30 kg	1400	3400
9	600-175	60 x 40 x 17.5 cm	2.25 kg	56.5 x 36.5 x 16.5 cm	34 L	30 kg	1400	3400
10	600-230	60 x 40 x 23 cm	2.5 kg	56.5 x 36.5 x 21.5 cm	44 L	35 kg	1400	3400
11	600-280	60 x 40 x 28 cm	2.75 kg	56.5 x 36.5 x 26.5 cm	55 L	40 kg	1400	3400
12	600-340	60 x 40 x 34 cm	3 kg	56.5 x 36.5 x 32.5 cm	67 L	60 kg	1400	3400
13	600-450	60 x 40 x 45 cm	3.7 kg	55.5 x 36 x 42 cm	84 L	70 kg	1200	3200
14	EUO-8623	80 x 60 x 23 cm	4.7 kg	76.5 x 56 x 21.5 cm	92 L	80 kg	500	1200
15	EUO-8628	80 x 60 x 28 cm	5.4 kg	76.5 x 56 x 26.5 cm	95 L	80 kg	500	1200
16	EUO-8633	80 x 60 x 34 cm	6 kg	76.5 x 56.5 x 32.5 cm	140 L	80 kg	500	1200

STACKABLE SOLID CRATES - FOOD GRADE

STACKABLE

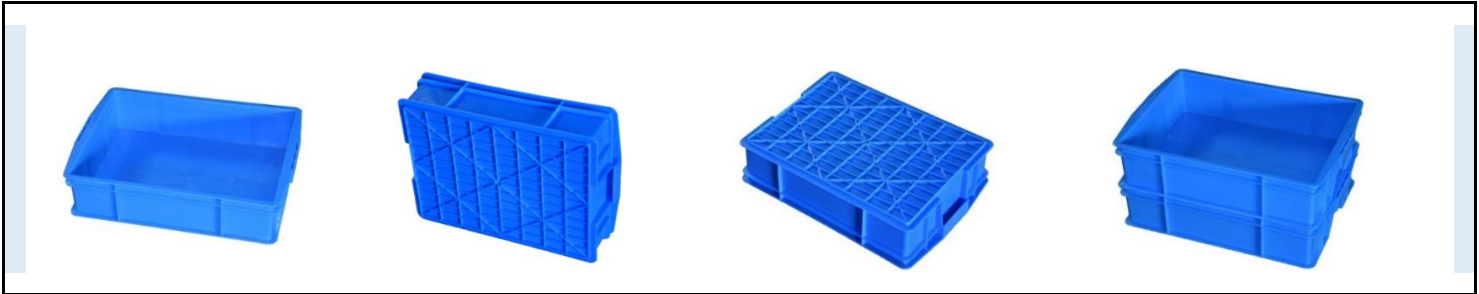

No	CODE	EXTERNAL SIZE (± 3%)	WEIGHT ± 5%	INTERANL SIZE (± 3%)	MANUAL LOADING	
					20FT	40HC
1	X22-7#	17.6 x 12.3 x 5.5 cm	0.1 kg	15.5 x 11 x 5 cm	26961	62016
2	X22-6#	21.3 x 14.5 x 6.3 cm	0.13 kg	18.5 x 12.8 x 5.5 cm	15984	37632
3	X22-5#	25.5 x 18 x 7.8 cm	0.22 kg	21.8 x 16.5 x 7 cm	8970	20774
4	X22-4#	31.5 x 20.5 x 8.8 cm	0.36 kg	27.5 x 19 x 8 cm	5346	12540
5	X23-320B	34.8 x 24 x 12.2 cm	0.55 kg	32 x 21.5 x 11.5 cm	2907	6732
6	X23-320A	35.5 x 26.7 x 12.5 cm	0.62 kg	32 x 24 x 12.2 cm	2432	5544
7	X24-4#	37.3 x 25.4 x 6.5 cm	0.31 kg	34.5 x 22.5 x 6 cm	4860	11808
8.1	X20-360-80	38.8 x 31 x 8.9 cm	0.55 kg	36 x 27.8 x 8 cm	2730	6510
8.2	X20-360-105	38.8 x 31 x 11.5 cm	0.6 kg	36 x 27.8 x 10.5 cm	2100	4991
9	X22-3#	39 x 24 x 10 cm	0.55 kg	34.5 x 21.5 x 9 cm	3105	7020
10	X19-380	41.5 x 31.2 x 15 cm	0.85 kg	38 x 27.7 x 14.5 cm	1470	3451
11	X18-392	43 x 34 x 20 cm	1.25 kg	39.2 x 30.5 x 19 cm	858	2184
12	X24-3#	43.8 x 29.3 x 8 cm	0.45 kg	41 x 26 x 7 cm	2639	7128
13	X22-2#	44 x 29.7 x 11.3 cm	0.85 kg	40 x 27.2 x 10.5 cm	1911	4347
L 14.1	X17-450-165	48.6 x 35.5 x 17.4 cm	1.4 kg	45 x 32 x 16.5 cm	936	2160
L 14.2	X17-450-235	48.6 x 35.5 x 24.5 cm	1.75 kg	45 x 32 x 23.5 cm	648	1440
15	X16-460B	49 x 33.5 x 17 cm	1.42 kg	46 x 30.5 x 16 cm	936	2520
16	X16-460A	49 x 36.5 x 17 cm	1.4 kg	46 x 33.5 x 16.5 cm	936	2160
17	X14-470	50 x 32 x 18 cm	1.4 kg	47 x 29 x 16.8 cm	1001	2352
18.1	X15-465-160	53 x 38 x 17 cm	1.65 kg	46.5 x 35 x 16 cm	858	1980
18.2	X15-465-200	53 x 38 x 21 cm	1.85 kg	46.5 x 35 x 20 cm	726	1584
18.3	X15-465-220	53 x 38 x 23 cm	1.85 kg	46.5 x 35 x 22 cm	660	1452
18.4	X15-465-280	53 x 38 x 29 cm	2.35 kg	46.5 x 35 x 28 cm	792	1650
L 19.1	X13-500-180	53.5 x 41.6 x 19.2 cm	1.6 kg	50 x 38 x 18 cm	660	1430
L 19.2	X13-500-230	53.5 x 41.6 x 24 cm	2.3 kg	50 x 38 x 23 cm	495	1210
L 19.3	X13-500-250	53.5 x 41.6 x 26 cm	2.5 kg	50 x 38 x 25 cm	495	1100
L 19.4	X13-500-290	53.5 x 41.6 x 30 cm	2.55 kg	50 x 38 x 29 cm	550	1320
L 19.5	X13-500-320	53.5 x 41.6 x 33.2 cm	2.65 kg	50 x 38 x 32 cm	550	1320
L 19.6	X13-500-350	53.5 x 41.6 x 36 cm	2.65 kg	50 x 38 x 35 cm	495	1045

STACKABLE SOLID CRATES - FOOD GRADE

STACKABLE

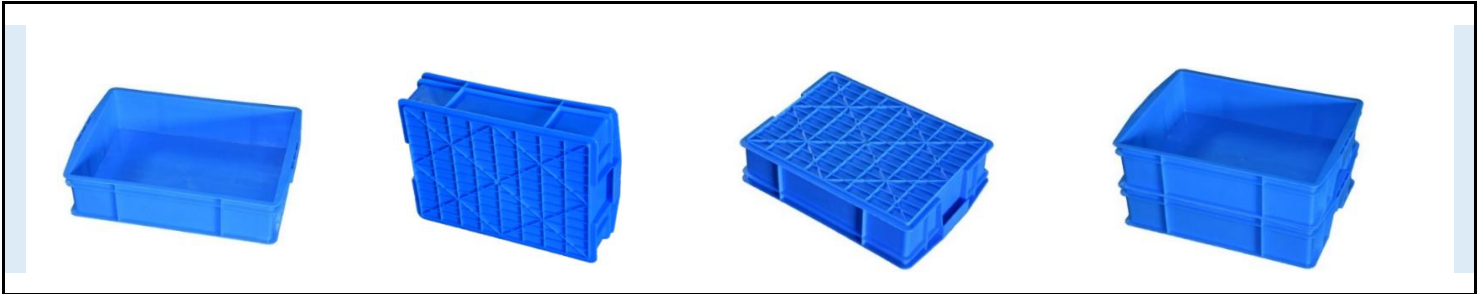

No	CODE	EXTERNAL SIZE (± 3%)	WEIGHT ± 5%	INTERANL SIZE (± 3%)	MANUAL LOADING	
					20FT	40HC
20	X12-510	54 x 37.5 x 28.5 cm	2.15 kg	51 x 34.5 x 27.5 cm	480	1188
21	X24-2#	55.7 x 37.5 x 8.3 cm	0.8 kg	52.3 x 34 x 7.5 cm	1680	4032
22	X21-2#	58 x 39 x 14.8 cm	1.4 kg	53.6 x 35.6 x 14.2 cm	960	2160
23	X11-525	59.2 x 36.5 x 26.5 cm	2.1 kg	52.5 x 32.3 x 25.3 cm	480	1200
24	X22-1#	60 x 37.9 x 12.8 cm	1.3 kg	46 x 34.5 x 12 cm	1188	2880
25	X10-550	60 x 40 x 15 cm	1.7 kg	55 x 36 x 14.5 cm	675	1700
L 26.1	X09-560-290	60.3 x 49.5 x 30.3 cm	3.2 kg	56 x 45.2 x 29 cm	252	608
L 26.2	X09-560-350	60.3 x 49.5 x 36.4 cm	3.5 kg	56 x 45.2 x 35 cm	324	722
L 27.1	X08-575-105	61 x 42 x 11.5 cm	1.45 kg	57.5 x 39 x 10.5 cm	900	2185
L 27.2	X08-575-145	61 x 42 x 15.5 cm	1.85 kg	57.5 x 39 x 14.5 cm	675	1615
L 27.3	X08-575-170	61 x 42 x 18 cm	1.86 kg	57.5 x 39 x 17 cm	585	1330
L 27.4	X08-575-210	61 x 42 x 22 cm	2.1 kg	57.5 x 39 x 21 cm	450	1140
L 27.5	X08-575-250	61 x 42 x 26 cm	2.56 kg	57.5 x 39 x 25 cm	405	950
L 27.6	X08-575-300	61 x 42 x 31 cm	2.3 kg	57.5 x 39 x 30 cm	315	760
L 27.7	X08-575-350	61 x 42 x 36 cm	2.3 kg	57.5 x 39 x 35 cm	405	950
L 27.8	X08-575-375	61 x 42 x 38.5 cm	3.15 kg	57.5 x 39 x 37.5 cm	405	855
28	X24-1#	62 x 41.3 x 9.7 cm	1.2 kg	58.5 x 38 x 8.5 cm	1080	2565
29	X21-1#	64 x 44 x 16.5 cm	1.8 kg	60.7 x 40.7 x 15.3 cm	630	1440
30	X06-604	65 x 44 x 35 cm	3.18 kg	60.4 x 39.6 x 33 cm	405	855
L 31	X07-600A	66.7 x 48.3 x 41 cm	4.7 kg	60 x 45 x 40 cm	208	648
32	X03-680	75 x 48 x 19.5 cm	2.8 kg	68 x 45 x 17.8 cm	336	832
33	X02-700A	76.5 x 55 x 46.5 cm	5.9 kg	70 x 51 x 44.8 cm	182	410
34	X01-780	84 x 64.2 x 48 cm	7.52 kg	78 x 58.2 x 46.7 cm	126	273

STACKABLE SOLID CRATES - INDUSTRIAL

STACKABLE



No	CODE	EXTERNAL SIZE (± 3%)	WEIGHT ± 5%	INTERANL SIZE (± 3%)	MANUAL LOADING	
					20FT	40HC
1.1	X59-300-115	30 x 20 x 11.5 cm	0.41 kg	25.5 x 15.5 x 9.5 cm	4180	10120
1.2	X59-300-147	30 x 20 x 14.7 cm	0.58 kg	25.5 x 15.5 x 13 cm	3344	7920
L 2.1	X58-400-115	40 x 30 x 11.5 cm	0.72 kg	35 x 25 x 9.5 cm	1960	4830
L 2.2	X58-400-148	40 x 30 x 14.8 cm	0.77 kg	35 x 25 x 13 cm	1568	3780
L 2.3	X58-400-220	40 x 30 x 22 cm	1.08 kg	35 x 25 x 20 cm	980	2520
L 2.4	X58-400-280	40 x 30 x 28 cm	1.29 kg	35 x 25 x 26 cm	1176	2730
L 3.1	X55-600-115	60 x 40 x 11.5 cm	1.2 kg	55 x 36 x 9.5 cm	900	2300
L 3.2	X55-600-148	60 x 40 x 14.8 cm	1.58 kg	55 x 36 x 13 cm	720	1800
L 3.3	X55-600-220	60 x 40 x 22 cm	2.04 kg	55 x 36 x 20 cm	450	1200
L 3.4	X55-600-280	60 x 40 x 28 cm	2.34 kg	55 x 36 x 26 cm	360	900
L 3.5	X56-A	60 x 40 x 28 cm	3.55 kg	55 x 36 x 26 cm	360	900
L 3.6	X55-600-325	60 x 40 x 32.5 cm	2.55 kg	55 x 36 x 31 cm	315	800
4	X54-635B	67 x 33.2 x 24.2 cm	2.16 kg	63.5 x 30 x 22.5 cm	504	1309
5	X54-635A	67 x 50.5 x 24.2 cm	3.17 kg	63.5 x 46.5 x 22.5 cm	288	748
6.1	X53-800-230	80 x 60 x 23 cm	4.02 kg	76.5 x 56.5 x 21 cm	210	495
6.2	X53-800-280	80 x 60 x 28 cm	4.48 kg	76.5 x 56.5 x 26 cm	168	405
6.3	X53-800-340	80 x 60 x 34 cm	5.25 kg	76.5 x 56.5 x 32.5 cm	147	315
7	X52-1000-280	100 x 40 x 28 cm	4.17 kg	94.5 x 35 x 27 cm	200	540
8.1	X51-1200-235	120 x 40 x 23.5 cm	4.72 kg	116 x 37 x 22.3 cm	200	550
8.2	X51-1200-280	120 x 40 x 28 cm	4.82 kg	116 x 37 x 26.8 cm	160	450

STACKABLE VENTED CRATES - FOOD GRADE

STACKABLE



No	CODE	EXTERNAL SIZE (± 3%)	WEIGHT ± 5%	INTERANL SIZE (± 3%)	MANUAL LOADING	
					20FT	40HC
1.1	K19-360-80	38.8 x 31 x 8.9 cm	0.35 kg	36 x 27.8 x 8 cm	2730	6510
1.2	K18-360-105	38.8 x 31 x 11.5 cm	0.55 kg	36 x 27.8 x 10.5 cm	2100	4991
2	K17-430	45.3 x 31.6 x 27.3 cm	1.1 kg	43 x 29 x 26.2 cm	1092	2366
3.1	K16-450-165	48.6 x 35.5 x 17.4 cm	0.95 kg	45 x 32 x 16.5 cm	936	2160
3.2	K16-450-235	48.6 x 35.5 x 24.5 cm	1.3 kg	45 x 32 x 23.5 cm	648	1440
4	K20-460	49.1 x 35.4 x 26.9 cm	1.55 kg	46 x 32.3 x 25.4 cm	864	1872
5.1	K53-1#	51.5 x 36.3 x 29.3 cm	1.95 kg	49.5 x 35 x 27.8 cm	726	1725
5.2	K54-2#	51.5 x 36.5 x 31 cm	1.85 kg	48.5 x 33.5 x 30 cm	627	1656
6	K15-490	52.3 x 36.4 x 31 cm	1.66 kg	49 x 33.3 x 30 cm	660	1656
7.1	K14-500-180	53.5 x 41.3 x 19 cm	1.15 kg	50 x 38 x 18 cm	660	1540
7.2	K15-500-250	53.5 x 41.3 x 26 cm	1.35 kg	50 x 38 x 25 cm	495	1100
7.3	K15-500-220	53.5 x 41.3 x 22.8 cm	1.35 kg	50 x 38 x 22 cm	550	1210
7.4	K15-500-290	53.5 x 41.3 x 30 cm	1.58 kg	50 x 38 x 29 cm	550	1320
7.5	K15-500-320	53.5 x 41.3 x 33.5 cm	1.7 kg	50 x 38 x 32 cm	550	1320
8	K13-510	55 x 39 x 28.5 cm	1.6 kg	51 x 35.2 x 27.5 cm	480	1134
9.1	K12-560-290	60 x 49.5 x 30 cm	2 kg	56 x 45.2 x 29 cm	252	640
9.2	K12-560-350	60 x 49.5 x 36 cm	2.25 kg	56 x 45.2 x 35 cm	324	800
10.3	K10-575-105	61 x 42.5 x 11.5 cm	1.1 kg	57.5 x 39 x 10.5 cm	900	2185
10.4	K10-575-145	61 x 42.5 x 15 cm	1.2 kg	57.5 x 39 x 14.5 cm	675	1615
10.5	K10-575-170	61 x 42.5 x 18 cm	1.3 kg	57.5 x 39 x 17 cm	585	1330
10.6	K10-575-210	61 x 42.5 x 22 cm	1.65 kg	57.5 x 39 x 21 cm	450	1140
10.7	K10-575-250	61 x 42.5 x 26 cm	1.75 kg	57.5 x 39 x 25 cm	405	950
10.8	K10-575-300	61 x 42.5 x 31 cm	2.1 kg	57.5 x 39 x 30 cm	315	760
10.1	K10-575-350	61 x 42.5 x 36.3 cm	2.35 kg	57.5 x 39 x 35 cm	405	950
10.2	K10-575-375	61 x 42.5 x 38.5 cm	2.7 kg	57.5 x 39 x 37.5 cm	405	855
11	K07-640	68.5 x 48.5 x 41 cm	3.15 kg	64 x 44 x 40 cm	224	612
12	K06-720	76 x 56 x 41.5 cm	3.9 kg	72 x 51.5 x 40 cm	196	540
13	K05-746	80 x 55 x 37.5 cm	3.45 kg	74.6 x 50 x 36.5 cm	168	420

STACKABLE VENTED CRATES - FOOD GRADE

STACKABLE



No	CODE	EXTERNAL SIZE (± 3%)	WEIGHT ± 5%	INTERANL SIZE (± 3%)	MANUAL LOADING	
					20FT	40HC
14.1	K04-755B	80.5 x 57.2 x 50.5 cm	4.15 kg	75.5 x 52.5 x 49.5 cm	168	392
14.2	K04-755A	80.5 x 57.2 x 50.5 cm	4.75 kg	75.5 x 52.5 x 49.5 cm	168	392
15.1	K03-780B	84 x 63.7 x 48 cm	4.5 kg	78 x 58 x 46.5 cm	126	294
15.2	K03-780A	84 x 63.7 x 48 cm	5.5 kg	78 x 58 x 46.5 cm	126	294
16	K02-880	93.5 x 64 x 56 cm	6.7 kg	89 x 59.5 x 54.5 cm	108	216
17	K01-1m	100.3 x 68 x 54 cm	7 kg	97.5 x 62.7 x 52.5 cm	90	216

ATTACHED LID CONTAINER

NESTABLE



No	CODE		EXTERNAL SIZE (± 3%)	WEIGHT ± 5%	NEST HEIGHT	PALLET LOADING			MANUAL LOADING	
						1 PT	20FT	40HC	20FT	40HC
1	4030XC260C	B	40 x 30 x 26 cm	1.65 kg	7.5 cm	140 158	1400	3480	1740	4100
2	4030XC315B	B	40 x 30 x 31.5 cm	2.1 kg	7.5 cm	140 158	1400	3480	1740	4100
3	X62-B	B	54 x 32 x 33.5 cm	2.7 kg	8.5 cm	126 140	1020	2500	1200	3080
4.1	6040XC260B	B	60 x 40 x 26 cm	2.8 kg	8.5 cm	80 90	800	2000	1000	2500
4.2	6040XC260A	A	60 x 40 x 26 cm	2.9 kg	12 cm	60 68	600	1500	720	1800
5	X60-C	C	60 x 40 x 28.5 cm	2.88 kg	12 cm	60 68	600	1500	720	1800
6.1	X61-B	B0	60 x 40 x 31.5 cm	2.9 kg	8 cm	80 90	800	2000	1000	2500
6.2	6040XC315B	B	60 x 40 x 31.5 cm	3 kg	8.5 cm	80 90	800	2000	1000	2500
6.3	6040XC315A	A	60 x 40 x 31.5 cm	3.1 kg	12 cm	60 68	600	1500	720	1800
7	X57-C	C	60 x 40 x 33.5 cm	3.09 kg	8.6 cm	80 90	800	2000	1000	2500
8	6040XC355B	B	60 x 40 x 35.5 cm	3.3 kg	8.5 cm	80 90	800	2000	1000	2500
9	6040XC365A	A	60 x 40 x 36.5 cm	3.3 kg	12 cm	60 68	600	1500	720	1800
10	6040XC412A	A	60 x 40 x 41.2 cm	3.5 kg	12.2 cm	56 65	560	1440	680	1720
11	6040XC462A	A	60 x 40 x 46.2 cm	3.7 kg	12.2 cm	56 65	560	1440	680	1720
12	7557XC625C	C	75 x 57 x 62.5 cm	8.1 kg	9.3 cm				459	1254

VENTED CRATES

NEST - STACK

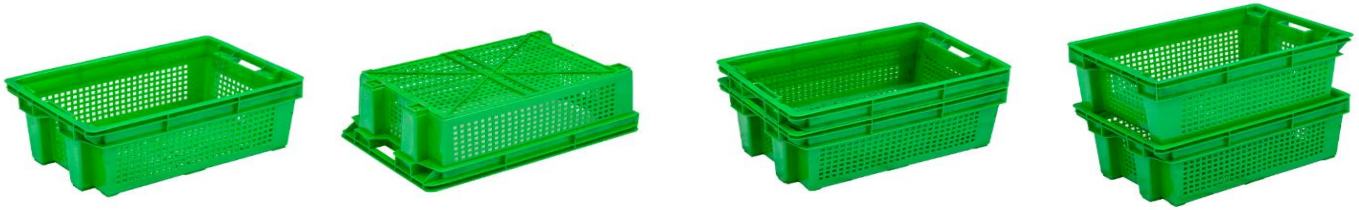

No	CODE	EXTERNAL SIZE (± 3%)	WEIGHT ± 5%	INTERANL SIZE (± 3%)	MANUAL LOADING	
					20FT	40HC
1	K52-2#	58 x 37 x 21 cm	1.5 kg	55 x 34 x 20 cm	1600	4000
2.1	K51-1#B	58.5 x 36.5 x 34 cm	2.3 kg	55.5 x 33.5 x 32.5 cm	1020	2500
2.2	K51-1#A	58.5 x 36.5 x 34 cm	2.5 kg	55.5 x 33.5 x 32.5 cm	1020	2500
3.1	Q24-1#	62.3 x 42.6 x 16.5 cm	1.28 kg	52.5 x 39.8 x 16 cm	2000	4800
3.2	Q24-2#	62.3 x 42.6 x 31.5 cm	2.2 kg	52.5 x 39.8 x 31 cm	1150	2850

VENTED CRATES - STEEL HANDLE

NEST - STACK



No	CODE	EXTERNAL SIZE (± 3%)	WEIGHT ± 5%	INTERANL SIZE (± 3%)	MANUAL LOADING	
					20FT	40HC
1	K09-560	63 x 43 x 30 cm	1.85 kg	56 x 39 x 29.2 cm	1200	2945
2.1	K08-630B	68 x 47.8 x 36.5 cm	1.9 kg	63 x 43.8 x 35.5 cm	896	2244
2.2	K08-630A	68 x 47.8 x 36.5 cm	2.3 kg	63 x 43.8 x 35.5 cm	896	2244

SOLID CRATES

NEST - STACK



No	CODE	EXTERNAL SIZE (± 3%)	WEIGHT ± 5%	INTERANL SIZE (± 3%)	MANUAL LOADING	
					20FT	40HC
1	Q22-510	59 x 38.5 x 20 cm	1.9 kg	51 x 35 x 19 cm	1980	4560
2.1	Q23-1#	62.3 x 42.6 x 16.5 cm	1.55 kg	52.5 x 39.8 x 16 cm	2000	4800
2.2	Q23-2#	62.3 x 42.6 x 31.5 cm	2.36 kg	52.5 x 39.8 x 31 cm	1150	2850

WATER CRATES

NESTABLE



No	CODE	EXTERNAL SIZE (± 3%)	WEIGHT ± 5%	INTERANL SIZE (± 3%)	MANUAL LOADING	
					20FT	40HC
1	X25-50L	53.5 x 39 x 30 cm	1.35 kg	49.5 x 34.5 x 29.2 cm	2770	6080
2	X25-90L	69 x 47.5 x 37.5 cm	2.5 kg	64 x 42 x 35.5 cm	960	2380
L 3	X05-630	69.5 x 48 x 37 cm	2.95 kg	63 x 43.5 x 36 cm	896	2244
4	X25-160L	76 x 56 x 49.5 cm	4.7 kg	70 x 50 x 48.5 cm	670	1680
5	X25-200L	81.7 x 61 x 59 cm	5.5 kg	73 x 53 x 57.5 cm	441	1050
6	X25-300L	87.7 x 65.5 x 61.7 cm	6.8 kg	80 x 57.5 x 61 cm	360	897

PLASTIC HANG AND SHELF BINS



NO	SKU	DIMENSIONS (CM)			WEIGHT	MATERIAL	LOADING CAPACITY	PCS/CTN	CTN SIZE (CM)	CBM
		L	W	H						
1	PK011N	110	x 105	x 50	0.050 kg	PP	3 kg	24	24 x 24 x 20	0.012
2	PK012N	140	x 105	x 75	0.075 kg	PP	3 kg	24	32 x 22 x 26	0.018
3	PK013N	190	x 105	x 75	0.075 kg	PP	4 kg	24	40 x 22 x 26	0.023
4	PK014N	220	x 140	x 125	0.125 kg	PP	10 kg	12	43 x 30 x 24	0.031
5	PK015N	270	x 140	x 125	0.125 kg	PP	10 kg	12	43 x 30 x 28	0.036



NO	SKU	DIMENSIONS (CM)			WEIGHT	MATERIAL	LOADING CAPACITY	PCS/CTN	CTN SIZE (CM)	CBM
		L	W	H						
1	PKS001	130	x 88	x 55	0.06 kg	PP	3 kg	50	45 x 15 x 43	0.029
2	PK001N	160	x 100	x 74	0.10 kg	PP	3 kg	50	54 x 18 x 57	0.055
3	PK006N	185	x 107	x 77	0.13 kg	PP	4 kg	64	49 x 39 x 49	0.094
4	PK002N	240	x 150	x 124	0.27 kg	PP	8 kg	36	51 x 50 x 55	0.140
5	PK007N	280	x 214	x 175	0.45 kg	PP	22 kg	16	22 x 28 x 18	0.011
6	PK003N	340	x 200	x 150	0.47 kg	PP	15 kg	18	65 x 36 x 68	0.159
7	PK021N	350	x 280	x 184	0.78 kg	PP	30 kg	8	62 x 37 x 60	0.138
8	PK008N	370	x 214	x 175	0.60 kg	PP	27 kg	8	49 x 39 x 52	0.099
9	PK010N	370	x 420	x 175	0.95 kg	PP	35 kg	4	46 x 39 x 53	0.095
10	PK022N	425	x 280	x 260	1.14 kg	PP	35 kg	8	64 x 46 x 90	0.265
11	PK004N	450	x 200	x 175	0.70 kg	PP	30 kg	12	66 x 47 x 56	0.174
12	PK005N	450	x 300	x 175	1.04 kg	PP	50 kg	8	66 x 47 x 56	0.174
13	PK023	450	x 365	x 180	1.10 kg	PP	35 kg	8	79 x 57 x 47	0.212
14	PK024	600	x 410	x 220	2.00 kg	PP	50 kg	8	88 x 64 x 71	0.400